

**CEPTER**

**USER MANUAL**  
**49" Curved Monitor**

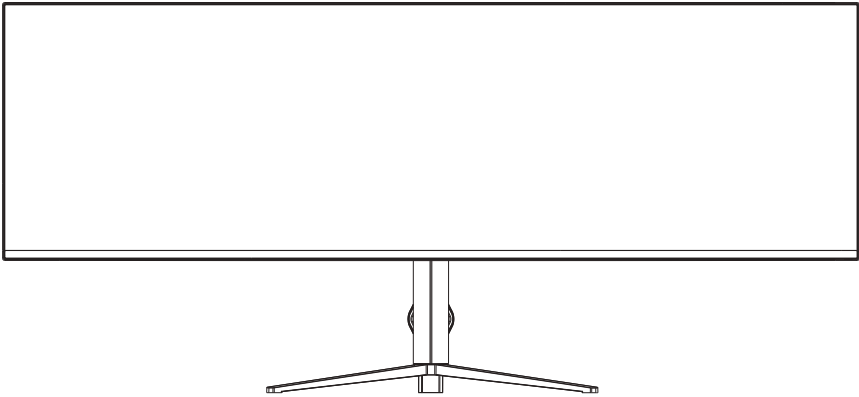

**C49PULSE2**

[www.ceptertech.com](http://www.ceptertech.com)



## **GB**

Thank you for choosing this Monitor.

Please read this instruction manual thoroughly before using and ensure you are familiar with the setup and operation of your new gaming gadget. Retain this instruction manual for future reference.

## **NO**

Takk for at du valgte denne Monitoren.

Les denne bruksanvisningen nøye før bruk, og sørg for at du er kjent med oppsett og bruk av ditt nye spilltilbehør.

Ta vare på denne bruksanvisningen for fremtidig referanse.

## **DK**

Tak, for at dit valg af dette Skærm.

Læs venligst denne brugsanvisning grundigt inden brug, og sørg for, at du er bekendt med opsætningen og driften af din nye spille-enhed.

Behold denne brugsanvisning til senere brug.

## **FI**

Kiitos, kun valitsit tämän monitori.

Lue nämä käyttöohjeet perusteellisesti ennen käyttöä ja varmista, että olet tutustunut uuden pelilaitteesi asettamiseen ja käyttöön.

Säilytä tämä käyttöopas tulevaa tarvetta varten.

## **SE**

Tack för att du valt denna skärm.

Läs noggrant bruksanvisningen innan du använder spelenheten, för att se till att du har kunskap om dess inställningar och funktioner.

Spara bruksanvisningen för framtida referens.

Instruction Manual – English .....	page	3 - 10
Bruksanvisning – Norsk .....	side	11 - 18
Brugervejledning – Dansk .....	side	19 - 26
Käyttöopas - Suomi .....	sivu	27 - 34
Bruksanvisning – Svenska .....	sida	35 - 42

EN

NO

DK

FI

SE

**Product introduction****Packing list**

Monitor



Stand

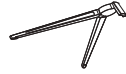

Base



User Manual

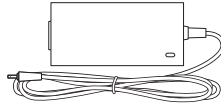

Power Adapter

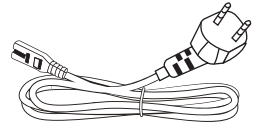

Power Cable

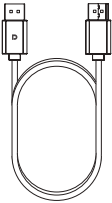

DP Cable

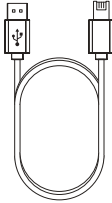

USB-A to B Cable

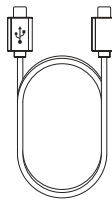

USB-C Cable

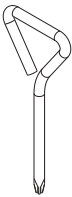

Screwdriver

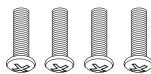

Screws x 4

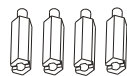

Mount Screws x 4

- Redundant screws can be used as spare screws.

**Installation****Installation of base**

1

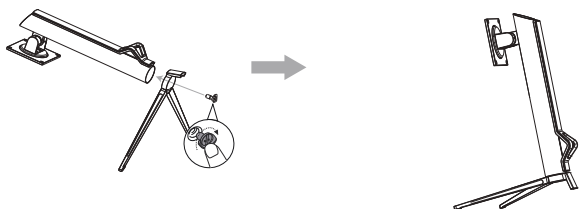

2

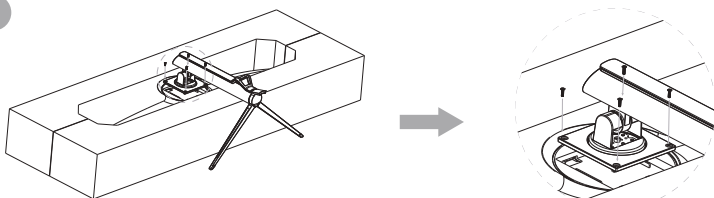

3

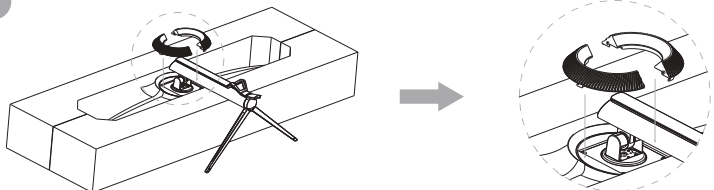

4

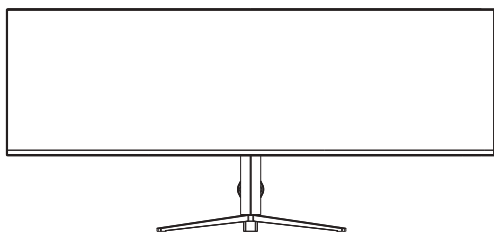

**!** Note: During standing of the whole monitor, do not press the liquid crystal screen with hand to avoid damage to the screen.

## Installation

### Installation of mount

1

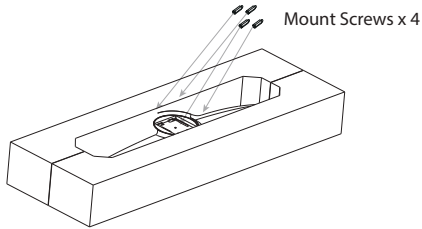

2

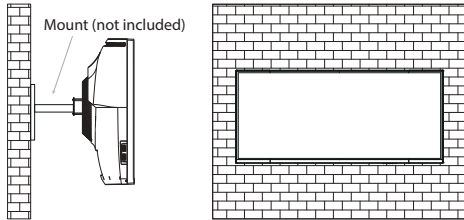

During padlocking of the monitor, do not pinch the screen with the hands to avoid damaging the screen. Install the mount to the mount stud by referring to the user manual of the mount (purchased separately).

Tips: The mounting hole distance of the mount for the product is 100x100mm.



Notes: To prevent the monitor on the mount from failing, please install it firmly and protect it fully. Do not place or hang any object on the mount, and the using height of the mount should be less than 2 meters.

## Adjusting the monitor

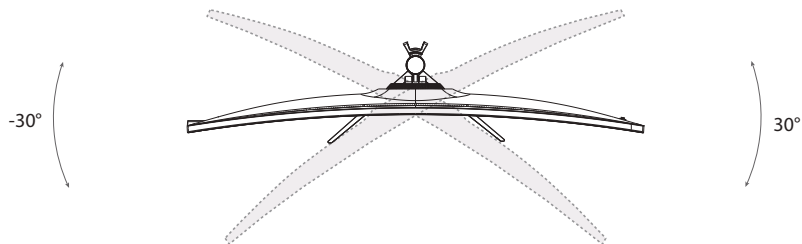

Rotation angle  
-30°, +30°

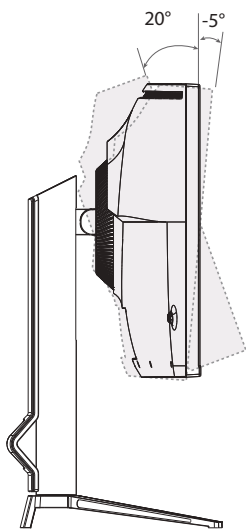

Tilting angle  
-5°, +20°

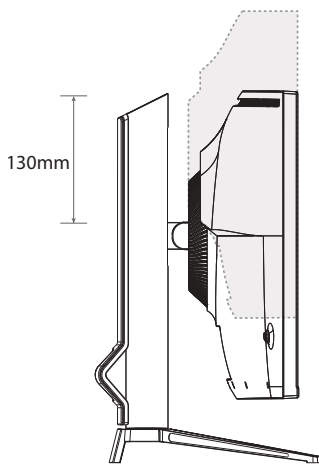





Height Adjustment  
130mm

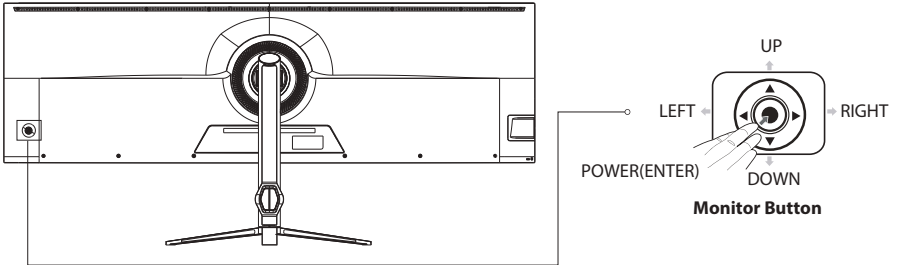

## Usage

## Description of buttons



Monitor Button	Action
 POWER / ENTER	Click the Power button to turn on the monitor, then click to enter the options menu.
 UP / DOWN	Allows for the brightness adjustment.
 LEFT	Allows for the selection of scenario patterns.
 RIGHT	Cross Aiming Shortcut Button (During Gameplay).

## Explanation of indicators

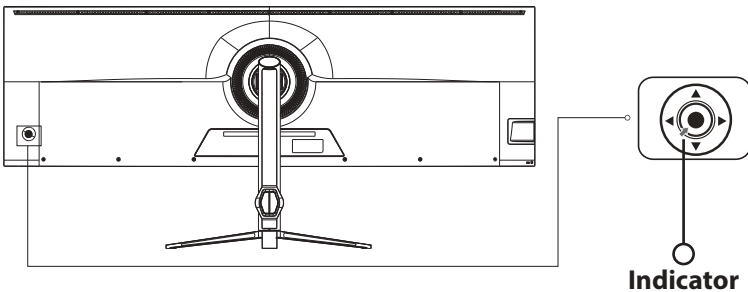

Indicator: Steady blue light indicates the power is on and the monitor runs normally. Please make sure that your computer is turned on and all video cables are fully plugged in and/or connected.

## OSD menu

## Menu description

- The color and shape of the OSD menu of the actual monitor may be slightly different from them shown in the figure.
  - Specifications of the OSD menu may change with improvements of functions without prior notice.
- The on-screen display (OSD) menu can be used to adjust the settings of the monitor and is displayed on the screen after turning on the monitor and pressing the ● button.

1. Press (●, ►) to enter the OSD screen.

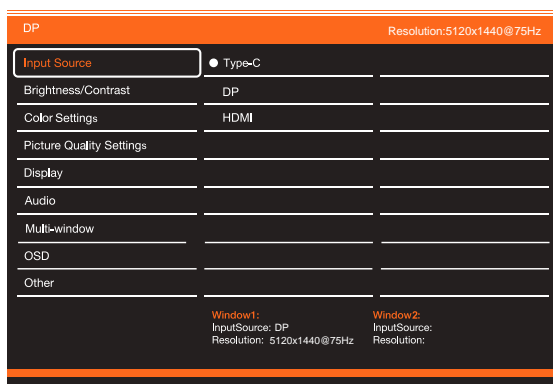
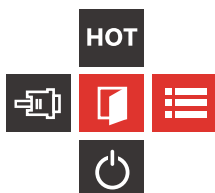

2. Press ◀ or ▶ to browse through the functions.

-Select the desired function, then press the ● button to enter the submenu.

-Press ◀ or ▶ to browse the sub-menus, and then press the ● key to confirm the selection of the desired function.

-Press ◀ or ▶ to select an option, then press ● to confirm the setting and exit the current menu.

## Specification

Product model		C49PULSE2
Screen Size		49" (124cm)
Aspect Ratio		32:9
Viewing Angle		178°(H) / 178°(V)
Pixel pitch		0.234 (H) × 0.234 (V) mm
Contrast ratio		1000:1(TYP)
Colors		1.07B (8 bit)
Resolution		5120x1440
Maximum refresh rate		75Hz
Power type		DC24V,6.25A
Ports		HDMI + DP+USB-C+USB-B+USB-Ax4 + Audio Out
Product Dimensions Lifting base	Without base	1215.25 x 129.91 x 365.8 mm
	With base	1215.25 x 252.11 x 553.53 mm
Tilting angle		Forward tilting : 5°; Backward tilting: 20°
Height range		130mm
Rotation angle		-30°, +30°
Speaker		2x3W
Net Weight		11.8KG
Gross Weight		17.1KG
Environmental conditions	Action	Temperature: 0°C~ 40°C (32°F ~ 104°F) Humidity: 10%~90% RH (non-condensing)
	Storage	Temperature: -20°~ 60° (-4°F ~ 140°F) Humidity: 5%~95% RH (non-condensing)



The terms HDMI and HDMI High-Definition Multimedia Interface, and the HDMI Logo are trademarks or registered trademarks of HDMI Licensing Administrator, Inc. in the United States and other countries.



**HDMI**™  
HIGH-DEFINITION MULTIMEDIA INTERFACE



-Dispose of all packaging, paper, cartons and plastic bags in accordance with your local recycling regulations.

-At the end of the product's lifespan, please dispose of it separately from your household waste at an authorized household WEEE waste recycling centre.

-For more information, please contact the local authority or the retailer where you purchased the product.

Power International AS,  
PO Box 523, 1471 Lørenskog, Norway

Power Norge:  
<https://www.power.no/kundeservice/>  
T: 21 00 40 00

Expert Danmark:  
<https://www.expert.dk/kundeservice/>  
T: 70 70 17 07

Power Danmark:  
<https://www.power.dk/kundeservice/>  
T: 70 33 80 80

Punkt 1 Danmark:  
<https://www.punkt1.dk/kundeservice/>  
T: 70 70 17 07

Power Finland:  
<https://www.power.fi/tuki/asiakaspalvelu/>  
T: 0305 0305

Power Sverige:  
<https://www.power.se/kundeservice/>  
T: 08 517 66 000

## Produktintroduksjon

### Pakkeliste



Skjerm



Gulvstativ



Sokkel



Bruksanvisning

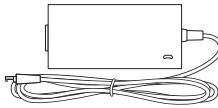

Strømadapter

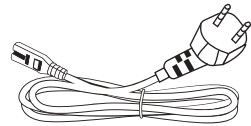

Power Cable

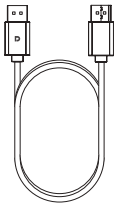

DP-kabel

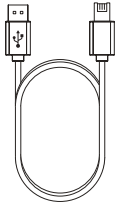

USB-A to B-kabel

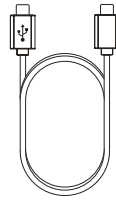

USB-C-kabel

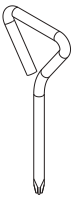

Skrutrekker

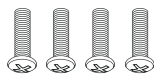

Skruer x 4

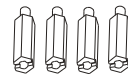

Festeskruer x 4

- Skruer som er til overs kan brukes som reserveskruer.

## Installasjon

## Montere sokkelen

1

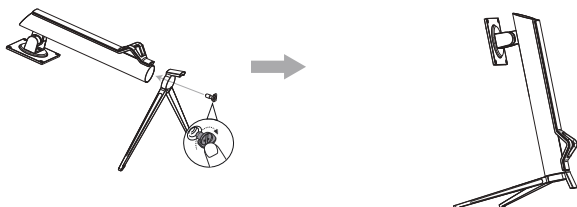

2

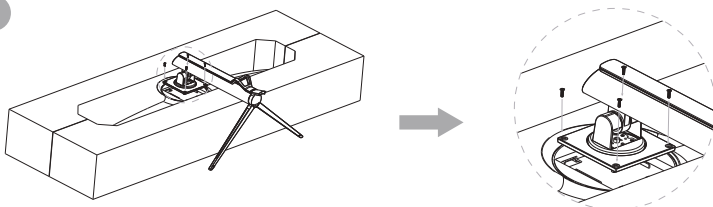

3

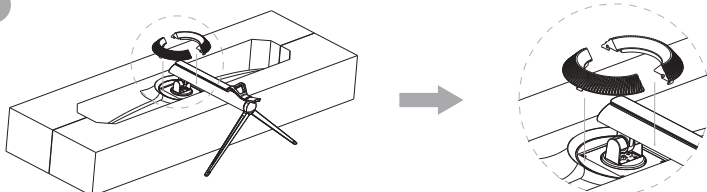

4

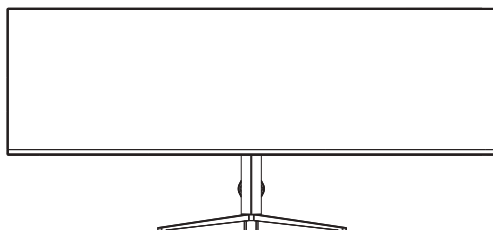

Merk: Når hele skjermen står, må du ikke trykke den med hånden for å unngå å skade skjermen.

## Installasjon

### Montere feste

1

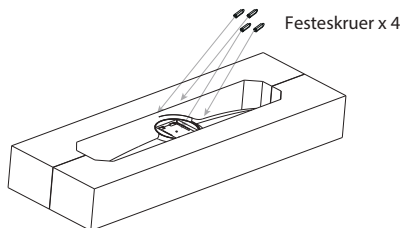

2

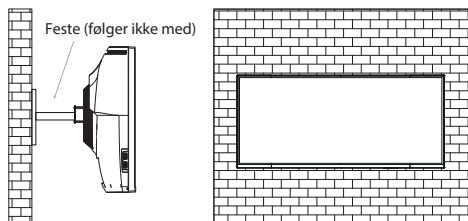

Når du låser skjermen med hengelås, må du ikke klemme den med hendene for å unngå å skade den. Sett festet på festetappen i henhold til bruksanvisningen til festet (kjøpes separat).

Tips: Avstanden til monteringshullet til produktets feste er 100x100mm.

Merk: For å forhindre at skjermen på festet svikter må den installeres godt og beskyttes fullstendig. Ikke plasser eller heng noen gjenstander på festet. Festet bør ikke brukes høyere enn 2 meter.

## Justere skjermen

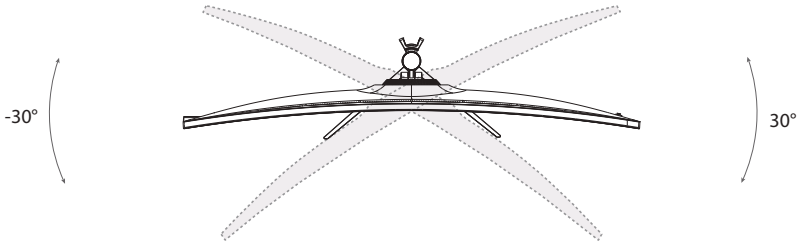

Rotasjonsvinkel  
-30°, +30°

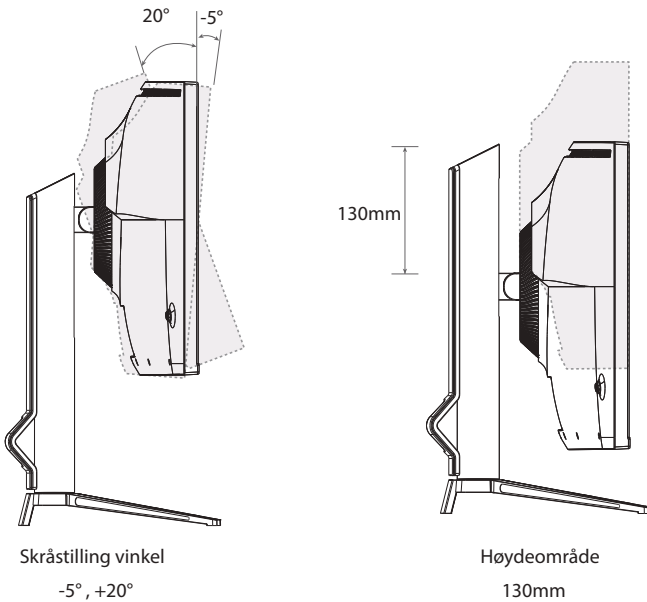





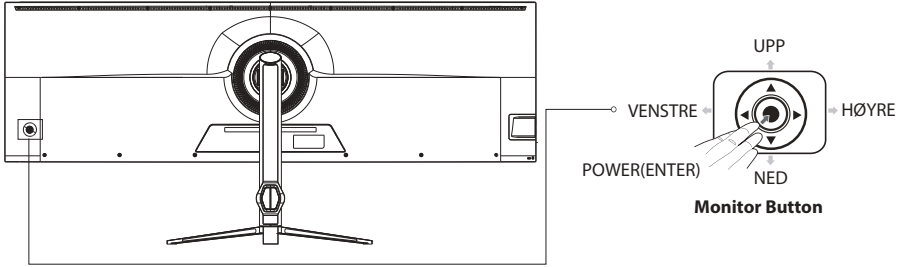

## Bruk

### Beskrivelse av knapper



Monitor Button	Action
 POWER / ENTER	Klikk på strømknappen for å slå på skjermen, og klikk deretter for å gå inn i alternativmenyen.
 OPP/NED	Tillater justering av lysstyrken.
 VENSTRE	Gir mulighet for valg av scenariomønstre.
 HØYRE	Snarveisknapp for kryssikting (Under spilling).

### Forklaring av indikatorer

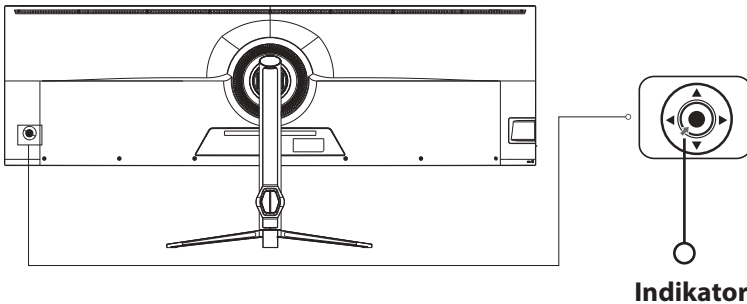

Indikator: Konstant blått lys indikerer at strømmen er på og skjermen kjører som normalt. Sørg for at datamaskinen er slått på og at alle videokabler er plugget inn og/eller tilkoblet.

## Skjermmeny

### Menybeskrivelse

- Fargen og formen på skjermmenyen til den faktiske skjermen kan være litt forskjellig fra det som vises på figuren.
- Spesifikasjoner for skjermmenyen kan endres med forbedringer av funksjoner uten forvarsel.

På skjermmenyen kan man justere innstillingene på skjermen. Den vises på skjermen når man har slått på skjermen og trykket ● knappen.

1. Trykk (●, ►) for å gå inn i skjermmenyen.

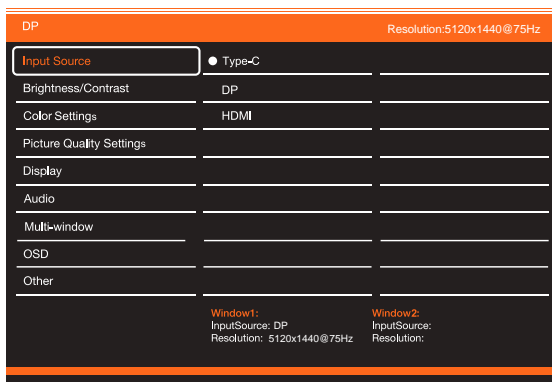
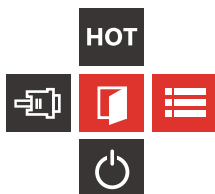

2. Trykk ◀ eller ▶ for å bla gjennom funksjonene.
  - Velg ønsket funksjon, og trykk deretter ● knappen for å gå inn i undermenyen.
  - Trykk ◀ eller ▶ for å bla gjennom undermenyene, og trykk deretter ● knappen for å bekrefte valget av ønsket funksjon.
  - Trykk ◀ eller ▶ for å velge et alternativ, og trykk deretter ● for å bekrefte innstillingen og gå ut av gjeldende meny.

## Spesifikasjoner

Produktmodell		C49PULSE2
Skjermstørrelse		49" (124cm)
Sideforhold		32:9
Betrakningsvinkel		178° (H) / 178° (V)
Pikselavstand		0,234 (H) × 0,234 (V) mm
Kontrastforhold		1000:1 (TYP)
Farger		1.07B (8 bit)
Oppløsning		5120x1440
Maksimal oppdateringsfrekvens		75 Hz
Strømtype		24V, 6.25A likestrøm
Porter		HDMI + DP+USB-C+USB-B+USB-Ax4 + lyd ut
Produktets mål Løftesokkel	Uten sokkel	1215,25 x 129,91 x 365,8 mm
	Med sokkel	1215,25 x 252,11 x 553,53 mm
Skråstillingsvinkel		Vipping forover: 5°; Vipping bakover: 20°
Høydeområde		130 mm
Rotasjonsvinkel		-30°, +30°
Høytaler		2x3W
Nettvekt		11.8KG
Bruttovekt		17.1KG
Miljøforhold	Handling	Temperatur: 0–40 °C (32–104 °F) Fuktighet: 10–90 % RF (ikke-kondenserende)
	Oppbevaring	Temperatur: -20–60 °C (-4–140 °F) Fuktighet: 5–95 % RF (ikke-kondenserende)



Begrepene HDMI og HDMI High-Definition Multimedia Interface, samt HDMI-logoen, er varemerker eller registrerte varemerker for HDMI Licensing Administrator, Inc., i USA og i andre land.



- Kast all emballasje, papir, kartonger og plastposer i samsvar med lokale regler for resirkulering.
- Når produktet ikke skal brukes lenger, må det avhendes adskilt fra husholdningsavfall hos en miljøstasjon for gjenvinning av elektrisk og elektronisk avfall.
- Du får nærmere informasjon ved å kontakte lokale myndigheter eller forhandleren du kjøpte produktet hos.

Power International AS,  
Postboks Box 523, 1471 Lørenskog, Norge

Power Norge:  
<https://www.power.no/kundeservice/>  
T: 21 00 40 00

Expert Danmark:  
<https://www.expert.dk/kundeservice/>  
T: 70 70 17 07

Power Danmark:  
<https://www.power.dk/kundeservice/>  
T: 70 33 80 80

Punkt 1 Danmark:  
<https://www.punkt1.dk/kundeservice/>  
T: 70 70 17 07

Power Finland:  
<https://www.power.fi/tuki/asiakaspalvelu/>  
T: 0305 0305

Power Sverige:  
<https://www.power.se/kundservice/>  
T: 08 517 66 000

## Produktintroduktion

### Pakkens indhold



Skærm

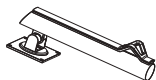

Fod

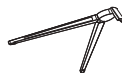

Fod



Brugervejledning

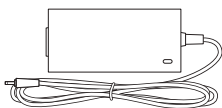

Strømadapter

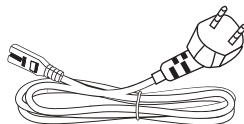

Power Cable

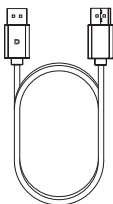

DP-kabel

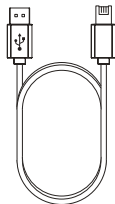

USB-A to B-kabel

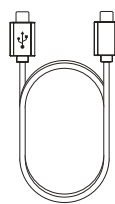

USB-C-kabel

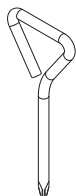

Skrutrækker

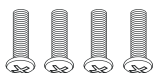

Skruer x 4

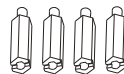

Skruer til vægmontering x 4

- Overskydende skruer kan bruges som reserveskruer.

## Opstilling

## Montering af foden

1

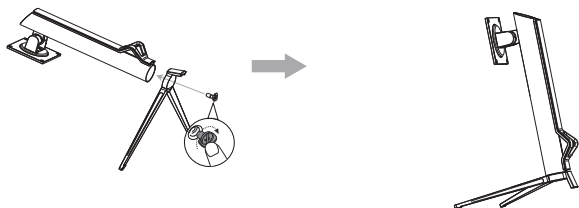

2

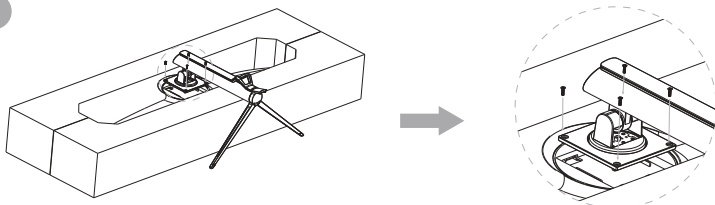

3

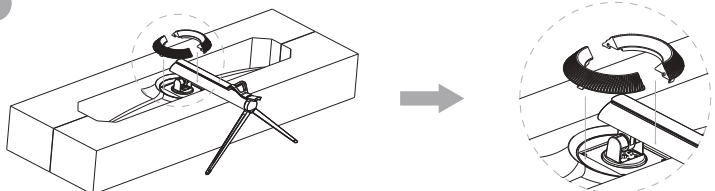

4

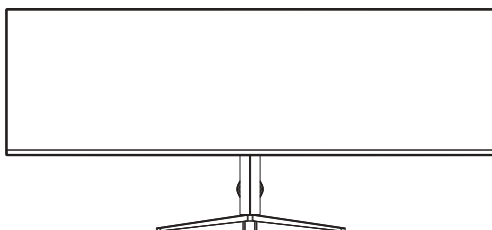

Bemærk: Når skærmen stilles op, skal du undgå at trykke på selve skærmen med hånden, da dette kan beskadige den.

## Opstilling

## Montering af ophænget

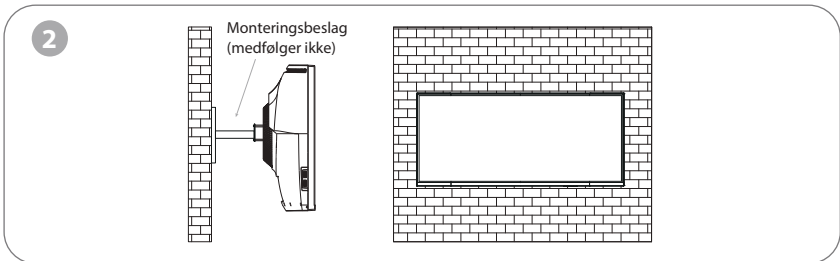
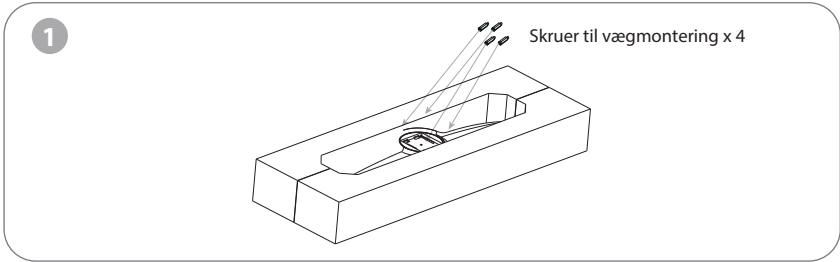

Hvis skærmen skal låses fast med en hængelås, skal du undgå at trykke på selve skærmen med hånden, da dette kan beskadige den. Monter ophænget på stiften, som vist i brugsvejledningen til ophænget (købes separat).

Tips: Afstanden mellem monteringshullerne 100 x 100 mm.

Bemærkninger: For at undgå, at skærmen falder ned, skal den monteres og fastgøres ordentligt. Anbring eller hæng ikke nogen genstand på ophænget. Det anbefales ikke, at hænge skærmen op i over 2 meters højde.

## Justering af skærmen

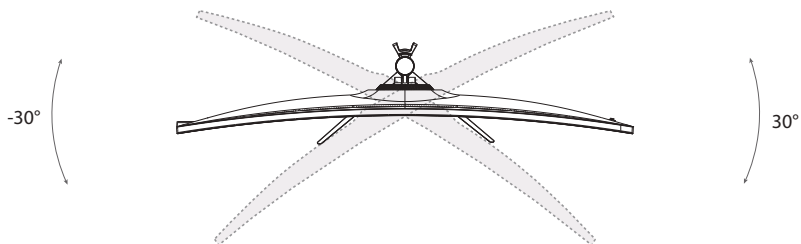

Drejevinkel

$-30^\circ, +30^\circ$

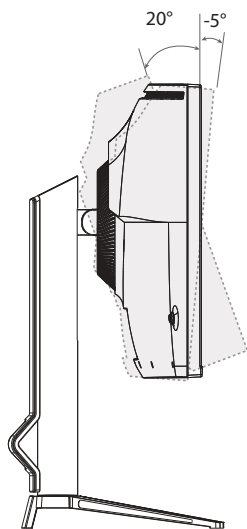

Vippevinkel

$-5^\circ, +20^\circ$

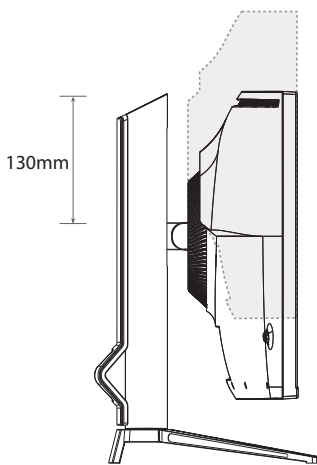

Højde Område





$130\text{mm}$

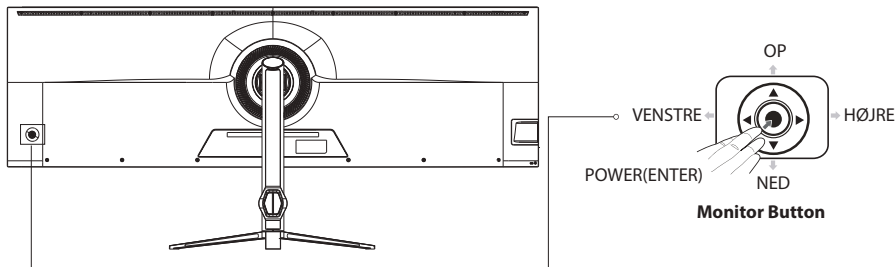

## Brug

## Beskrivelse af knapperne



Monitor Button	Action
 POWER / ENTER	Klik på tænd/sluk-knappen for at tænde for skærmen, og klik derefter på for at åbne indstillingsmenuen.
 OP/NED	Giver mulighed for justering af lysstyrken.
 VENSTRE	Giver mulighed for valg af scenariemønstre.
 HØJRE	Genvejsknop til krydsretning (Under gameplay).

## Forklaring af indikatorerne

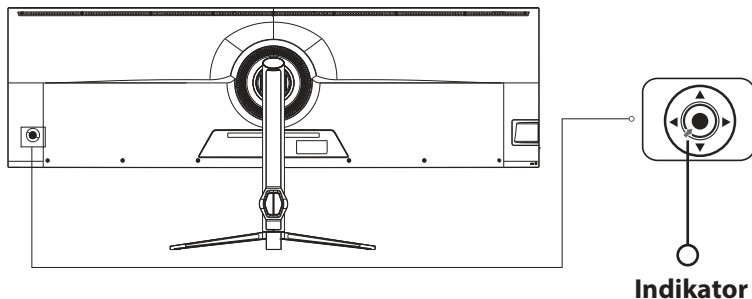

Lysindikator: Når indikatoren lyser blå betyder det, at strømmen er tændt, og at skærmen virker normalt. Sørg for, at din computer er tændt, og at alle videokabler er forbundet ordentligt.

## Skærmmenuen

### Menubeskrivelse

- Farven og formen på skærmmenuen på den faktiske skærm er muligvis ikke ens med skærmen på billedet.
- Særmmenuens funktioner ændres muligvis for, at forbedre dem. Dette kan ændres uden forudgående varsel.

I skærmmenuen (OSD) kan du justere skærmens indstillinger, hvilket vises på skærmen, når den tændes og der trykkes på ● knappen.

1. Tryk(●, ►) for at åbne skærmmenuen.

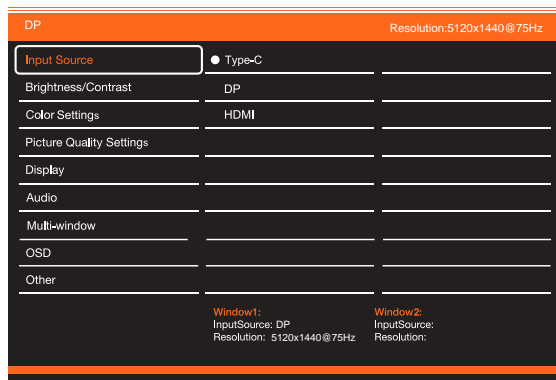
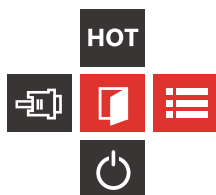

2. Brug ▲ og ◀▶ til, at skifte mellem punkterne.
  - Vælg det ønskede punkt, og tryk derefter på ● knappen for at åbne undermenuen.
  - Brug ▲ og ▶ til, at skifte mellem undermenuerne, og tryk derefter på ● knappen for, at bekræfte valget af det ønskede punkt.
  - Brug ▲ og ▶ til, at vælge et punkt, og tryk derefter på ● for at bekræfte indstillingen og lukke den aktuelle menu.

## Specifikationer

Produktmodel		C49PULSE2
Skærmstørrelse		49" (124cm)
Billedforhold		32:9
Synsvinkel		178° (H)/178° (V)
Pixelafstand		0,234 (H) × 0,234 (V) mm
Kontrastforhold		1000:1 (TYP.)
Farver		1.07B (8 bit)
Opløsning		5120x1440
Maksimal opdateringshastighed		75Hz
Strømtype		Jævnstrøm 24V, 6.25A
Porte		HDMI + DP+USB-C+USB-B+USB-Ax4 + Lydudgang
Produktmål Løftebund	Uden fod	1215,25 x 129,91 x 365,8 mm
	Med fod	1215,25 x 252,11 x 553,53 mm
Hældningsvinkel		Hældning fremad: 5°; Hældning bagud: 20°
Højde Område		130 mm
Drejevinkel		-30°, +30°
Højtaler		2 x 3W
Nettovægt		11.8KG
Bruttovægt		17.1KG
Miljøbetingelser	Handling	Temperatur: 0°C~ 40°C (32°F ~ 104°F) Luftfugtighed: 10~ 90 % RH ikke-kondenserende
	Opbevaring	Temperatur: -20°~ 60° (-4°F ~ 140°F) Luftfugtighed: 5~ 95 % RH (ikke-kondenserende)



Udtrykkene HDMI og HDMI High-Definition Multimedia Interface og HDMI-logoet er varemærker eller registrerede varemærker tilhørende HDMI Licensing LLC i USA og andre lande.



- Bortskaf alt emballage, papir, kartoner og plastposer i overensstemmelse med dine lokale genbrugsbestemmelser.
- Ved slutningen af produktets levetid, skal det bortskaffes separat fra dit husholdningsaffald på et godkendt genbrugsplads.
- Kontakt de lokale myndigheder eller forhandleren for yderligere oplysninger.

Power International AS,  
PO Box 523, 1471 Lørenskog, Norway

Power Norge:  
<https://www.power.no/kundeservice/>  
T: 21 00 40 00

Expert Danmark:  
<https://www.expert.dk/kundeservice/>  
T: 70 70 17 07

Power Danmark:  
<https://www.power.dk/kundeservice/>  
T: 70 33 80 80

Punkt 1 Danmark:  
<https://www.punkt1.dk/kundeservice/>  
T: 70 70 17 07

Power Finland:  
<https://www.power.fi/tuki/asiakaspalvelu/>  
T: 0305 0305

Power Sverige:  
<https://www.power.se/kundeservice/>  
T: 08 517 66 000

## Tuotteen esittely

### Pakkausluettelo



Monitori



Jalusta

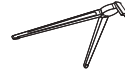

Pohjaosa



Käyttöopas

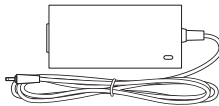

Virtasovitin

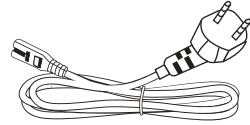

Power Cable

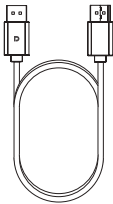

DP-kaapeli

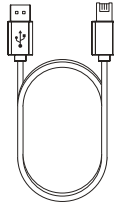

USB-A to B-kaapeli

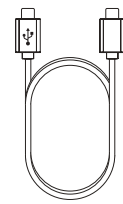

USB-C-kaapeli

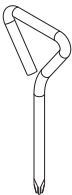

Ruuvitalta

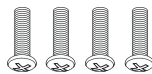

Ruuvit x 4

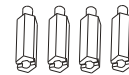

Kiinnitysruuvit x 4

- Ylimääräisiä ruuveja voidaan käyttää vararuuveina.

## Asennus

## Alustan asennus

1

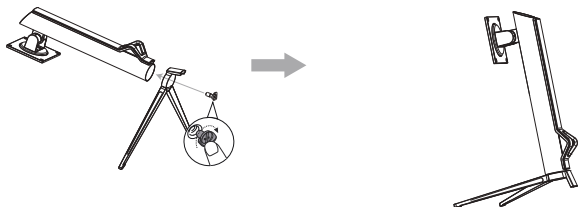

2

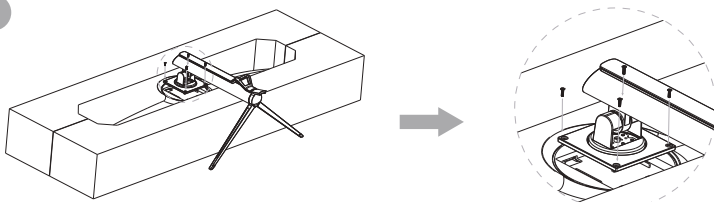

3

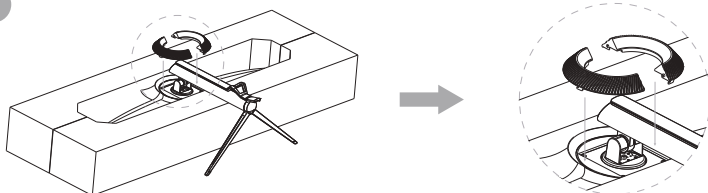

4

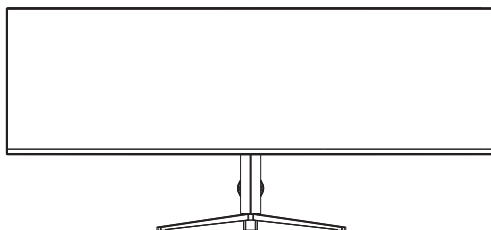

Huomautus: Älä paina nestekidenäyttöä käsin koko näytön seisomisen aikana, jotta näyttö ei vahingoitu.

## Asennus

## Kiinnikkeen asennus

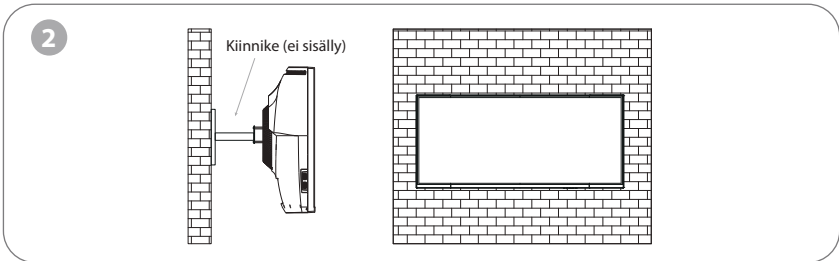
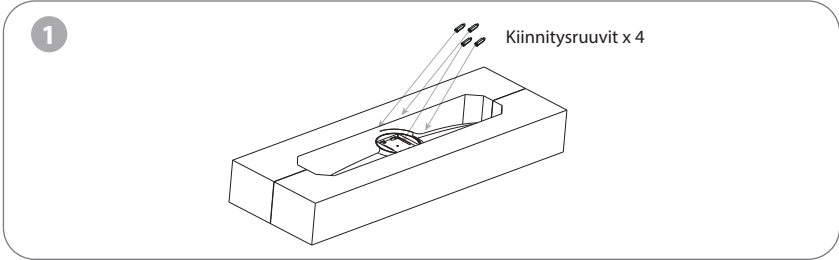

Älä purista näyttöä käsillä näyttöä lukittaessasi, jotta näyttö ei vahingoitu. Asenna kiinnike kiinnitystappiin kiinnikkeen käyttöohjeen mukaisesti (erikseen hankittava).

Vinkkejä: Tuotteen kiinnikkeen kiinnitysreikien etäisyys on 100x100mm.

Huomautuksia: Asenna se tukevasti ja suojaa se kokonaan, jotta kiinnikkeessä oleva näyttö ei rikkoudu. Älä aseta tai ripusta mitään esineitä kiinnikkeeseen, ja kiinnikkeen käyttökorkeuden on oltava alle 2 metriä.

## Näytön säätäminen

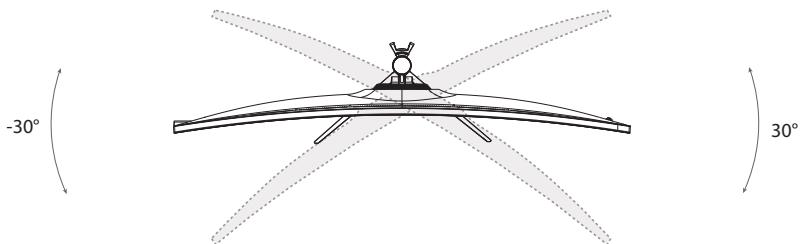

Kiertokulma

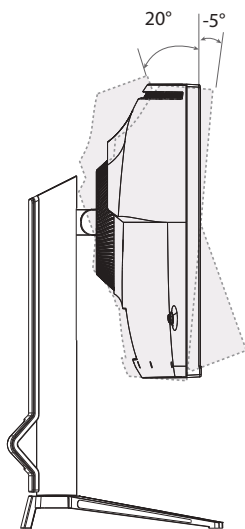
 $-30^{\circ}$ ,  $+30^{\circ}$ 

Kallistuskulma

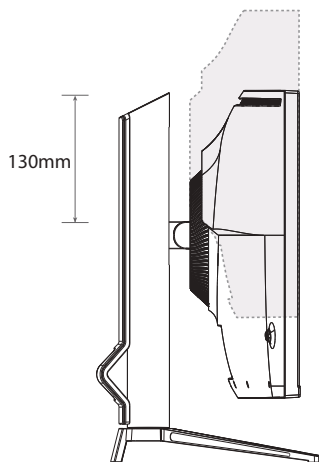
 $-5^{\circ}$ ,  $+20^{\circ}$ 

Korkeusalue





130mm

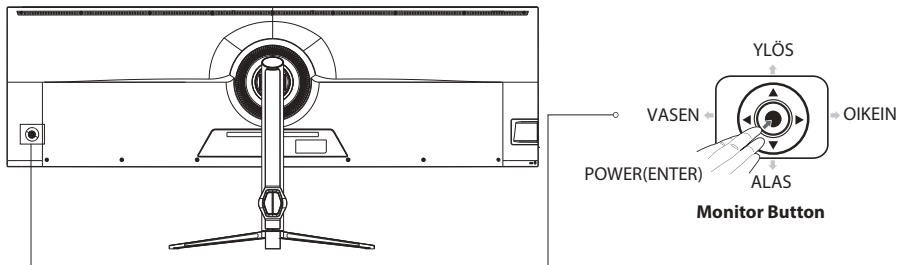

## Käyttö

### Painikkeiden kuvaus



Monitor Button	Action
 POWER / ENTER	Napsauta virtapainiketta käynnistääksesi näytön ja napsauta sitten siirtyäksesi asetusvalikkoon.
 YLÖS/ALAS	Mahdollistaa kirkkauden säätämisen.
 VASEN	Mahdollistaa skenaariomallien valinnan.
 OIKEIN	Cross Aiming pikan äppäin (Pelauksen aikana).

### Ilmaisimien selitys

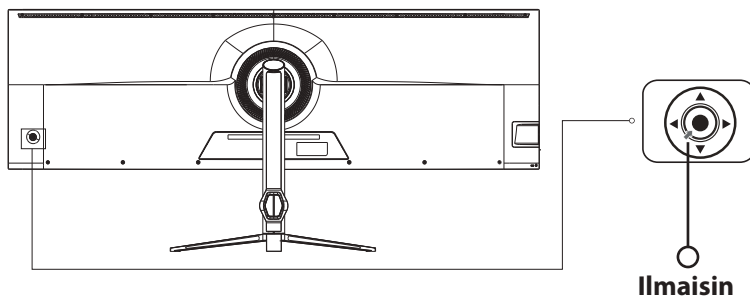

**Ilmainen:** Tasainen sininen valo osoittaa, että virta on kytketty ja näyttö toimii normaalisti. Varmista, että tietokone on päällä ja että kaikki videokaapelit on kytketty ja/tai liitetty.

## OSD-valikko

### Valikon kuvaus

- Varsinaisen näytön OSD-valikon väri ja muoto voivat poiketa hieman kuvassa esitetystä.
- OSD-valikon tekniset tiedot voivat muuttua toimintojen parannusten myötä ilman ennakoilmoitusta.

Näytön näyttövalikkoa (OSD-valikko) voidaan käyttää monitorin asetusten säätämiseen, ja se tulee näyttöön, kun monitori on kytketty päälle ja ● -painiketta painetaan.

1. Paina (●, ►) siirtyäksesi OSD-näyttöön.

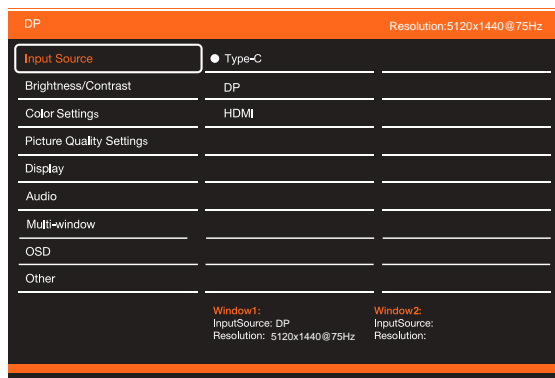
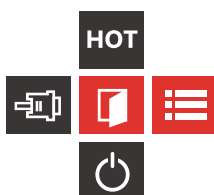

2. Selaa toimintoja painamalla ◀ tai ▶.
  - Valitse haluamasi toiminto ja siirry sitten alivalikkoon painamalla ● painiketta.
  - Selaa alivalikoita painamalla ◀ tai ▶ ja vahvista sitten haluamasi toiminnon valinta painamalla ● näppäintä.
  - Valitse vaihtoehto painamalla ◀ tai ▶ ja vahvista sitten asetukset painamalla ● ja poistu nykyisestä valikosta.

## Tekniset tiedot

Tuotteen malli		C49PULSE2
Näyttöruudun koko		49" (124cm)
Kuvasuhte		32:9
Katselukulma		178°(H) / 178°(V)
Pikseliväli		0,234 (H) × 0,234 (V) mm
Kontrastisuhte		1000:1 (TYP)
Värit		1.07B (8 bit)
Resoluutio		5120x1440
Suurin virkistystaajuus		75 Hz
Tehotyyppe		DC24V, 6.25A
Satamat		HDMI + DP + USB-C + USB-B + USB-Ax4 + Audio Out (äänilähtö)
Tuotteen mitat Nostoalusta	Ilman jalustaa	1215,25 x 129,91 x 365,8 mm
	Jalustan kanssa	1215,25 x 252,11 x 553,53 mm
Kallistuskulma		Eteenpäin kallistus: 5°; Kallistus taaksepäin: 20°
Korkeusalue		130 mm
Kiertokulma		-30°, +30°
Puhuja		2x3W
Nettopaino		11.8KG
Bruttopaino		17.1KG
Ympäristöolosuhteet	Toiminto	Lämpötila: 0 - 40°C (32 - 104°F) Kosteus: 10 - 90 % RH (ei-kondensoituvaa)
	Säilytys	Lämpötila: -20 - 60° (-4°F ~ 140°F) Kosteus: 5 - 95 % RH (ei-kondensoituvaa)



Termit HDMI ja HDMI High-Definition Multimedia Interface sekä HDMI-logo ovat HDMI Licensing Administrator, Inc:n tavaramerkkejä tai rekisteröityjä tavaramerkkejä Yhdysvalloissa ja muissa maissa.



- Hävitä kaikki pakkaukset, paperi, kartongit ja muovipussit paikallisten kierrätysmääräysten mukaisesti.
- Hävitä tuote käyttöiän päätyttyä erillään kotitalousjätteestäsi valtuutetussa kotitalouksien sähkö- ja elektroniikkalaiteromun kierrätyskeskuksessa.
- Lisätietoja saat paikallisilta viranomaisilta tai jälleenmyyjältä, josta ostit tuotteen.

Power International AS,  
PO Box 523, 1471 Lørenskog, Norway

Power Norjassa:  
<https://www.power.no/kundeservice/>  
P: 21 00 40 00

Expert Tanskassa:  
<https://www.expert.dk/kundeservice/>  
P: 70 70 17 07

Power Tanskassa:  
<https://www.power.dk/kundeservice/>  
P: 70 33 80 80

Punkt 1 Tanskassa:  
<https://www.punkt1.dk/kundeservice/>  
P: 70 70 17 07

Power Suomessa:  
<https://www.power.fi/tuki/asiakaspalvelu/>  
P: 0305 0305

Power Ruotsissa:  
<https://www.power.se/kundeservice/>  
P: 08 517 66 000

## Produktpresentation

### Innehåll i förpackningen



Bildskärm



Stativ

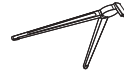

Bas



Bruksanvisning

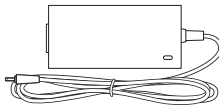

Strömadapter

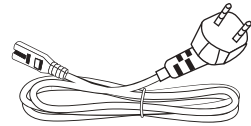

Power Cable

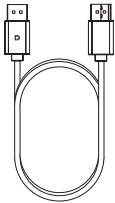

DP-kabel

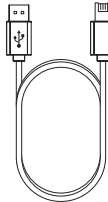

USB-A to B-kabel

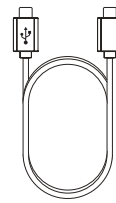

USB-C-kabel

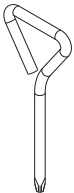

Skrivmejsel

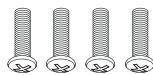

Skrudar x 4

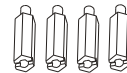

Monteringskrudar x 4

- Kvarvarande skruvar kan användas som reservskruvar.

**Installation****Installation av basen**

1

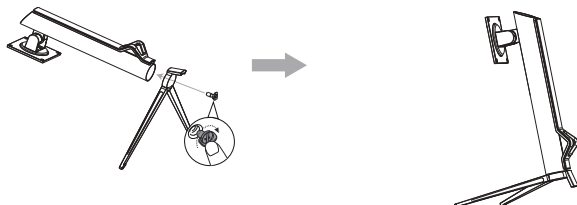

2

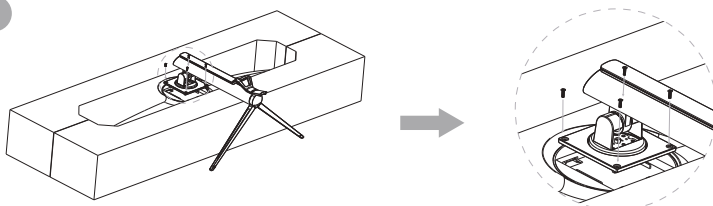

3

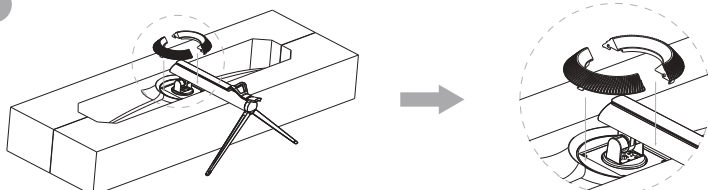

4

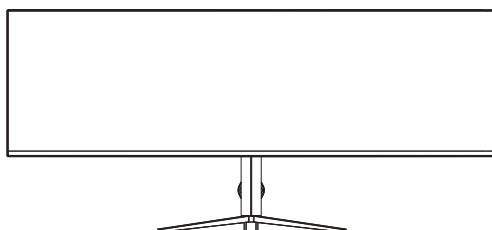

Obs: När du ställer upp skärmen får du inte trycka på LCD-skärmen med handen för att undvika skador på den.

## Installation

### Montering av fäste

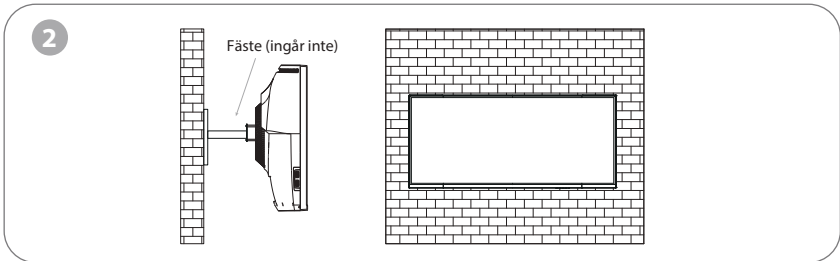
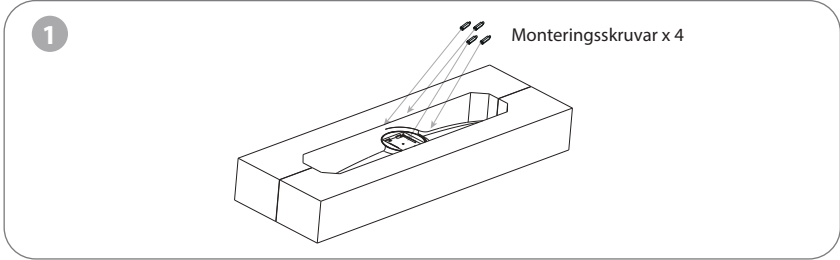

När du låser skärmen med hänglås får du inte klämma på skärmytan med händerna för att undvika att skärmen skadas. Installera fästet på fästbulten med hjälp av monteringsfäste bruksanvisning (köpt separat).

Tips: Monteringshåls avståndet för fästet för produkten är 100 x 100mm.

Noter: För att förhindra att skärmen på fästet inte går sönder ska du installera den ordentligt och skydda den helt och hållet. Placera inte eller häng något föremål på fästet och fästets användningshöjd bör vara mindre än 2 meter.

## Justera bildskärmen

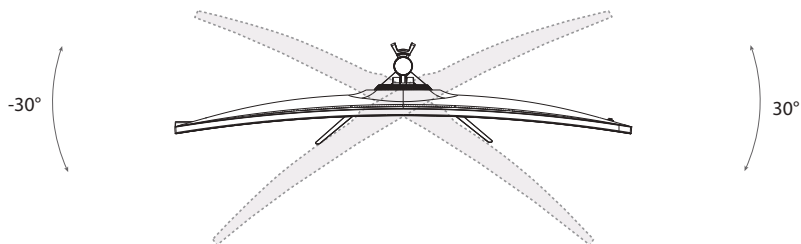

Rotationsvinkel

-30°, +30°

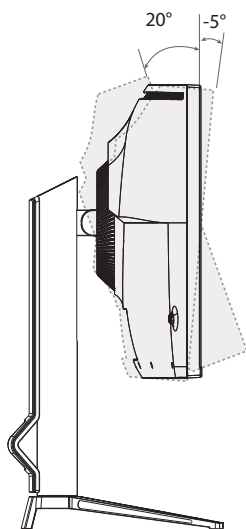

Lutningsvinkel

-5°, +20°

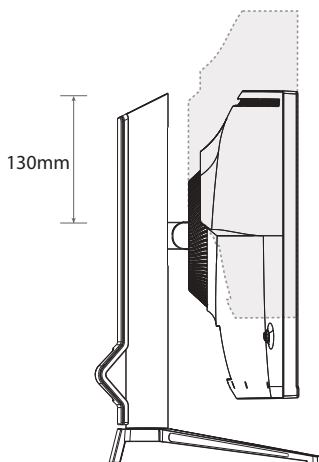

Höjdintervall





130mm

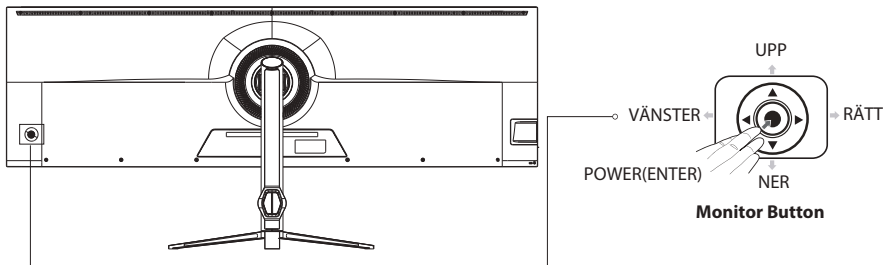

## Användning

### Beskrivning av knappar



Monitor Button	Action
 POWER / ENTER	Klicka på strömknappen för att slå på monitorn och klicka sedan för att öppna alternativmenyn.
 UPP/NER	Möjliggör justering av ljusstyrkan.
 VÄNSTER	Möjliggör val av scenariomönster.
 RÄTT	Korsiktning genvägsknapp (Under spel).

### Förklaring av indikatorer

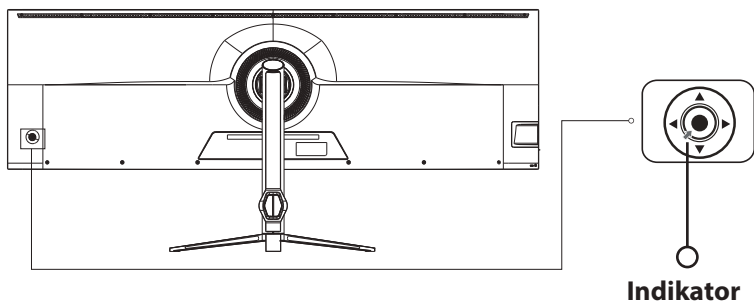

Indikator: Ett stadigt blått ljus visar att strömmen är på och att skärmen fungerar normalt. Kontrollera att datorn är påslagen och att alla videokablar är helt anslutna.

## OSD-menyn

### Beskrivning av meny

- Färgen och formen på OSD-menyn på den aktuella skärmen kan skilja sig något från dem som visas i figuren.
- Specifikationer för OSD-menyn kan ändras med förbättrade funktioner utan föregående meddelande.

OSD-menyn (On-screen display) kan användas för att justera skärmens inställningar och visas på skärmen efter att du har slagit på skärmen och trycker ● knappen.

1. Tryck (●, ►) för att öppna OSD-skärmen.

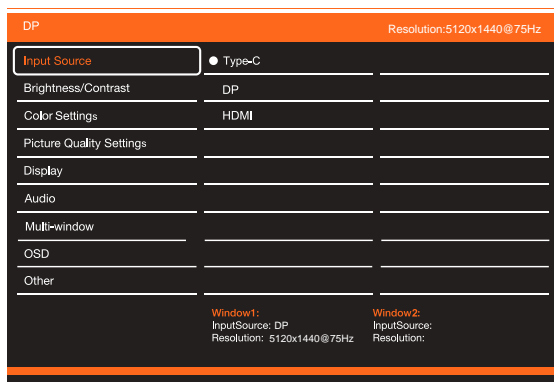
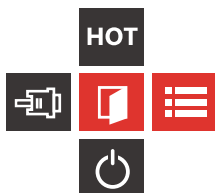

2. Tryck på ◀ eller ▶ för att bläddra bland funktionerna.
  - Välj önskad funktion och tryck sedan på ● knappen för att komma till undermenyn.
  - Tryck på ◀ eller ▶ för att bläddra i undermenyerna och tryck sedan på ● för att bekräfta valet av önskad funktion.
  - Tryck på ◀ eller ▶ för att välja ett alternativ och tryck sedan på ● för att bekräfta inställningen och lämna den aktuella meny.

## Specifikationer

Produktmodell	C49PULSE2	
Skärmstorlek	49" (124cm)	
Bildförhållande	32:9	
Visningsvinkel	178°(H) / 178°(V)	
Pixelavstånd	0,234 (H) × 0,234 (V) mm	
Kontrastförhållande	1000:1(TYP)	
Färger	1.07B ( 8 bit)	
Upplösning	5120x1440	
Maximal uppdateringsfrekvens	75 Hz	
Strömtyper	DC24V,6.25A	
Portar	HDMI + DP + USB-C + USB-B + USB-Ax4 + Ljudutgång	
Produktmått Lyftbas	Utan bas	1215,25 x 129,91 x 365,8 mm
	Med bas	1215,25 x 252,11 x 553,53 mm
Lutningsvinkel	Framåtlutning: 5°; bakåtlutning: 20°	
Höjdintervall	130 mm	
Rotationsvinkel	-30°, +30°	
Högtalare	2x3W	
Nettovikt	11.8KG	
Bruttovikt	17.1KG	
Miljöförhållanden	Åtgärd	Temperatur: 0°C~ 40°C Luftfuktighet: 10%~90% RH (icke-kondenserande)
	Förvaring	Temperatur: -20°~ 60°C Luftfuktighet: 5%~95% RH (icke-kondenserande)



Termerna HDMI och HDMI High-Definition Multimedia Interface samt HDMI-logotypen är varumärken eller registrerade varumärken som tillhör HDMI Licensing Administrator, Inc. i USA och andra länder.



- Kassera allt förpackningsmaterial, papper, kartonger och plastpåsar i enlighet med ditt lands lokala regler för återvinning.
- I slutet av produktens livslängd, kassera separat från hushållsavfallet på en godkänd WEEE-återvinningsstation.
- För ytterligare information, kontakta din kommun eller återförsäljare där du köpte produkten..

Power International AS,  
PO Box 523, N-1471 Lørenskog, Norge

Power Norge:  
<https://www.power.no/kundeservice/>  
T: 21 00 40 00

Expert Danmark:  
<https://www.expert.dk/kundeservice/>  
T: 70 70 17 07

Power Danmark:  
<https://www.power.dk/kundeservice/>  
T: 70 33 80 80

Punkt 1 Danmark:  
<https://www.punkt1.dk/kundeservice/>  
T: 70 70 17 07

Power Finland:  
<https://www.power.fi/tuki/asiakaspalvelu/>  
T: 0305 0305

Power Sverige:  
<https://www.power.se/kundeservice/>  
T: 08 517 66 000

**CEPTER**