

CEPTER

USER MANUAL
18.5" Portable Monitor



CNANO185

www.ceptertech.com

GB

Thank you for choosing this Monitor.

Please read this instruction manual thoroughly before using and ensure you are familiar with the setup and operation of your new gadget.

Retain this instruction manual for future reference.

NO

Takk for at du valgte denne Monitoren.

Les denne bruksanvisningen nøye før bruk, og sørg for at du er kjent med oppsett og bruk av ditt nye spilltilbehør.

Ta vare på denne bruksanvisningen for fremtidig referanse.

DK

Tak, for at dit valg af dette Skærm.

Læs venligst denne brugsanvisning grundigt inden brug, og sørg for, at du er bekendt med opsætningen og driften af din nye spille-enhed.

Behold denne brugsanvisning til senere brug.

FI

Kiitos, kun valitsit tämän monitori.

Lue nämä käyttöohjeet perusteellisesti ennen käyttöä ja varmista, että olet tutustunut uuden pelilaitteesi asettamiseen ja käyttöön.

Säilytä tämä käyttöopas tulevaa tarvetta varten.

SE

Tack för att du valt denna skärm.

Läs noggrant bruksanvisningen innan du använder spelenheten, för att se till att du har kunskap om dess inställningar och funktioner.







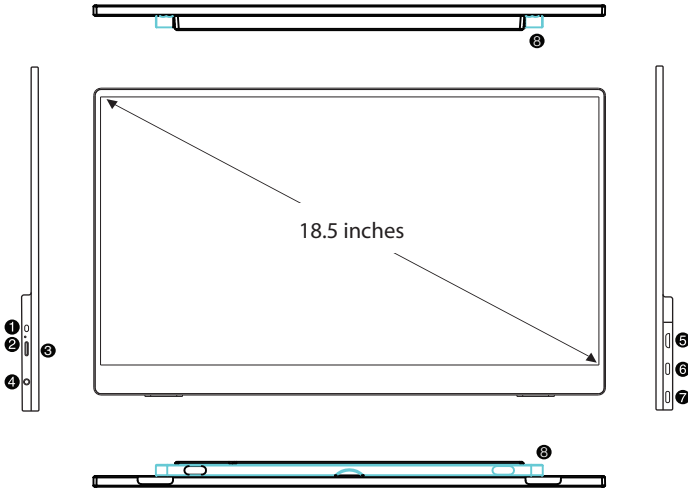

Spara bruksanvisningen för framtida referens.

Instruction Manual – English	page	3 - 10
Bruksanvisning – Norsk	side	11 - 18
Brugervejledning – Dansk	side	19 - 26
Käyttöopas - Suomi	sivu	27 - 34
Bruksanvisning – Svenska	sida	35 - 42

Usage

Description of buttons



❶		On / Off	Power On And Off / Return Button
❷		LED Power Indicator	Power Light
❸		Scroll Wheel	Menu Button
❹		3.5mm Headphones Output	External Audio Connector, Headset
❺		Mini HD Input	Mini HD Type Data Connector
❻		USB-C Input	Full Function USB-C Port
❼		USB-C Input	Full Function USB-C Port
❽		Support	160° Rotation Spindle

Adjusting the monitor

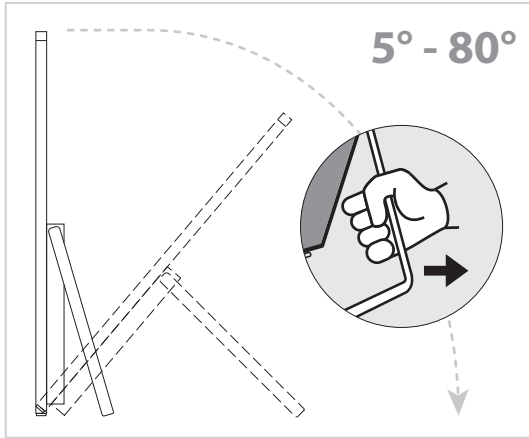

NOTE: Please be mindful of your finger placement while adjusting the monitor's viewing angle to avoid injury.

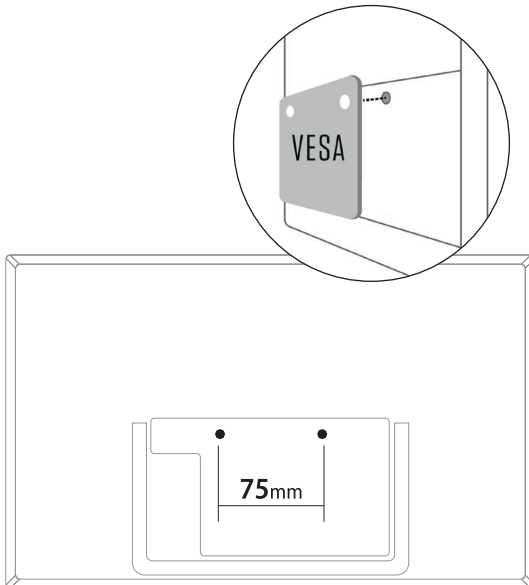

Product introduction

Packing list



Monitor Screen

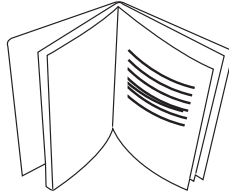

User Manual

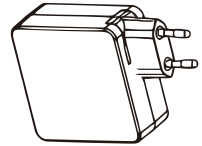

5V - 4A Adapter

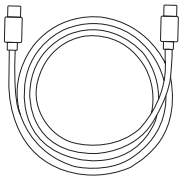

USB-C Cable

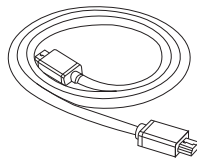























Mini HD to HD Cable

CONNECTION AND POWER SUPPLY

Plug In

Some laptops may not provide enough power to the monitor. Check the USB-C port on your laptop for the symbols shown in the table below. If you have one of the green checked symbols, then your USB-C port will provide data and enough power to the monitor. Note, MacBook ports are compatible even if there are no symbols next to it.

			
			
		All Apple laptops are compatible	

CONNECTION AND POWER SUPPLY

ATTENTION: The monitor can be connected to devices through different signal transmission modes, which a 5V/4A power source is required.

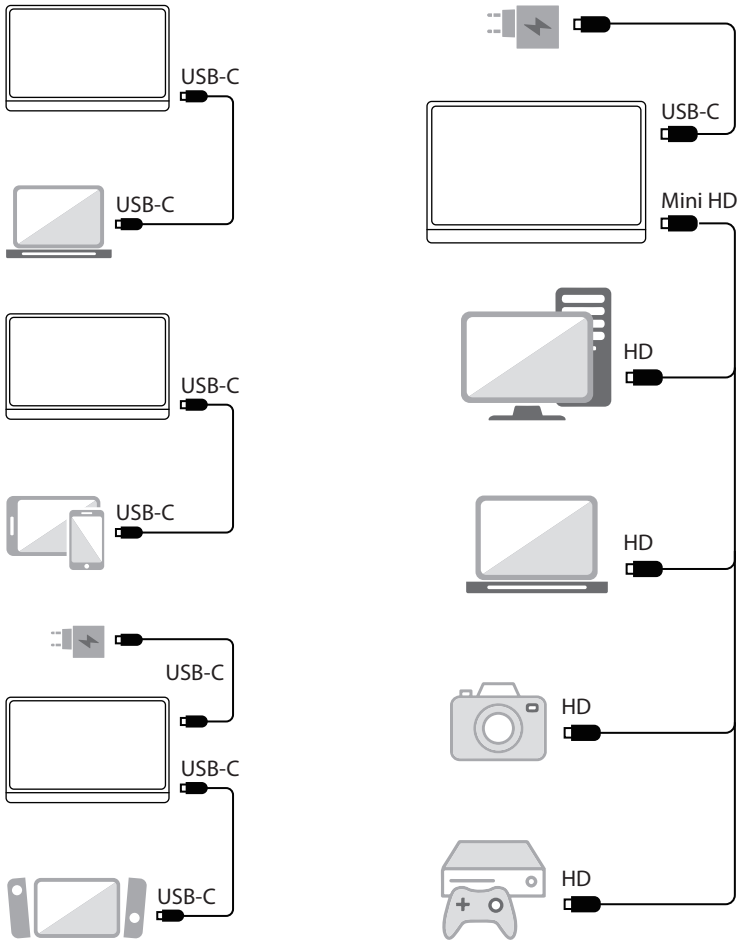

Make sure the USB-C port on your laptops/smart phones and other devices can support at least Thunderbolt 3.0 Standard when you are using USB-C connecting.

OSD MENU

Menu Description

- The on - screen display (OSD) menu can be used to adjust the settings of the monitor.

To access the main menu, simply press the Scroll Wheel once.

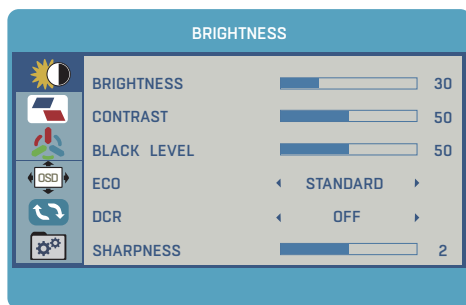

SPECIFICATION

Model Name	CNANO185	
Panel	Display size	18.5"
	Brightness(Typical)	250cd/m2
	Contrast (Typical)	1000:1
	Resolution (H x V)	1920 x 1080
	Aspect Ratio	16:9
	Color Gamut	NTSC 72%
	Refresh Rate	75Hz
Interface	Input 1	USB-C x 2
	Input 2	Mini HD x 1
Output Terminal	Earphone	3.5mm Earphone x 1
	Speaker	1W x 2
Power	Consumption	Typical 7.5W, Max 16W
	PowerInput	USB-C (DC5V/4A)
Physical	Dimensions (W*D*H)	423 x 250 x 18mm
	Net Weight	1.13 KG (±20g)
	Gross Weight	2 KG (±20g)
Environmental Conditions	Action	Temperature: 5°C ~ 50°C
		Humidity: 20% ~ 85%
	Storage	Temperature: -20°C ~ 55°C
		Humidity: 5% ~ 85%



-Dispose of all packaging, paper, cartons and plastic bags in accordance with your local recycling regulations.

-At the end of the product's lifespan, please dispose of it separately from your household waste at an authorized household WEEE waste recycling centre.

-For more information, please contact the local authority or the retailer where you purchased the product.

Power International AS,
PO Box 523, 1471 Lørenskog, Norway

Power Norge:
<https://www.power.no/kundeservice/>
T: 21 00 40 00

Expert Danmark:
<https://www.expert.dk/kundeservice/>
T: 70 70 17 07

Power Danmark:
<https://www.power.dk/kundeservice/>
T: 70 33 80 80

Punkt 1 Danmark:
<https://www.punkt1.dk/kundeservice/>
T: 70 70 17 07







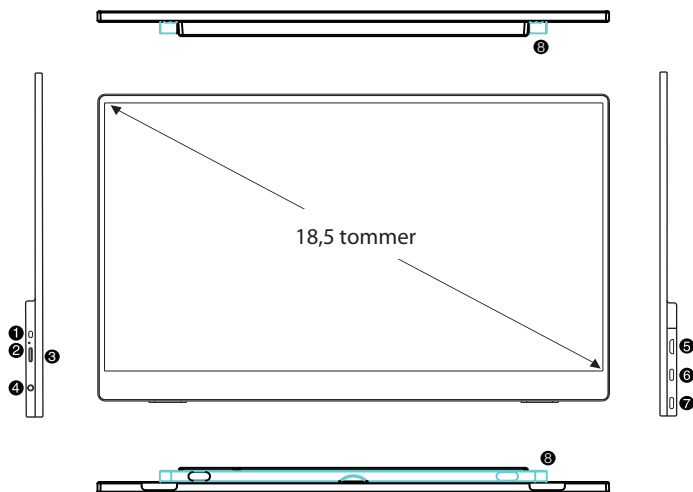

Power Finland:
<https://www.power.fi/tuki/asiakaspalvelu/>
T: 0305 0305

Power Sverige:
<https://www.power.se/kundeservice/>
T: 08 517 66 000

Bruk

Beskrivelse av knapper



❶		På/av	Slå på og av / Retur-knapp
❷		LED-strømindikator	Strømlampe
❸		Rullehjul	Meny-knapp
❹		3,5 mm hodetelefonutgang	Ekstern lydkontakt, hodesett
❺		Mini HD-inngang	Mini HD-datakontakt
❻		USB-C-inngang	Fullfunksjons USB-C-port
❼		USB-C-inngang	Fullfunksjons USB-C-port
❽		Støtte	160° rotasjonsspindel

Justere skjermen

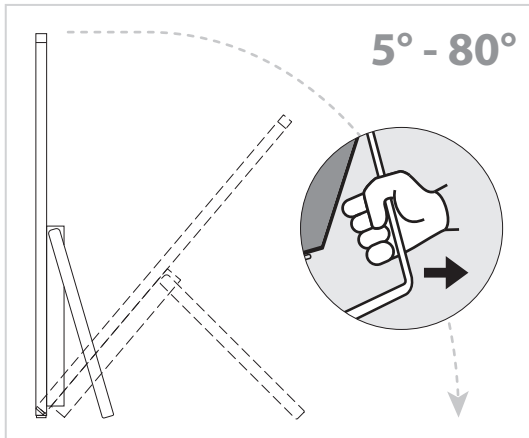

MERK: Vær oppmerksom på hvor du har fingrene når du justerer skjermens visningsvinkel for å unngå skade.

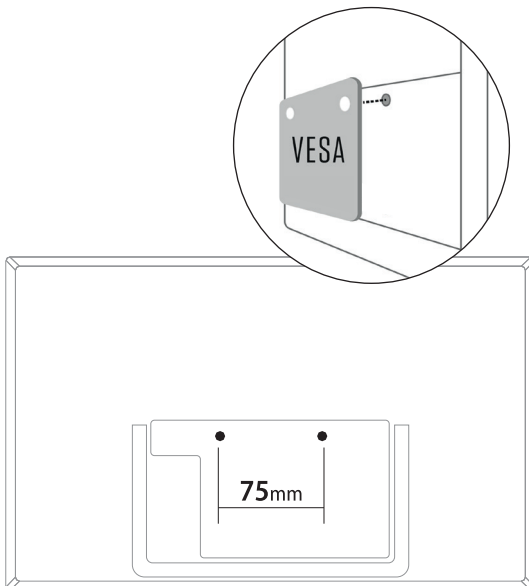

Produktintroduksjon

Pakkeliste



Skjerm

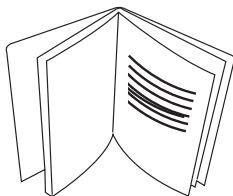

Bruksanvisning

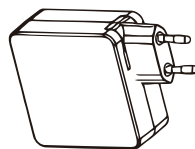

5 V 4A adapter

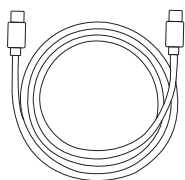

USB-C-kabel

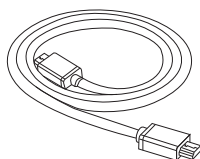











Mini HD- til HD-kabel

TILKOBLING OG STRØMFORSYNING

Koble til

Noen bærbare datamaskiner gir kanskje ikke nok strøm til skjermen. Se på USB-C-porten på den bærbare datamaskinen etter symbolene vist i tabellen nedenfor. Hvis du har et av de grønne avmerkede symbolene, vil USB-C-porten gi data og nok strøm til skjermen. Merk at MacBook-porter er kompatible selv om det ikke er noen symboler ved siden av.

	✓		✓
	✓		✓
	✓	Alle bærbare Apple-maskiner er kompatible	✓

	✗		✗
	✗		✗
	✗		✗

TILKOBLING OG STRØMFORSYNING

OBS: Skjermen kan kobles til enheter gjennom forskjellige signaloverføringsmoduser, som krever en 5 V / 4 A strømkilde.

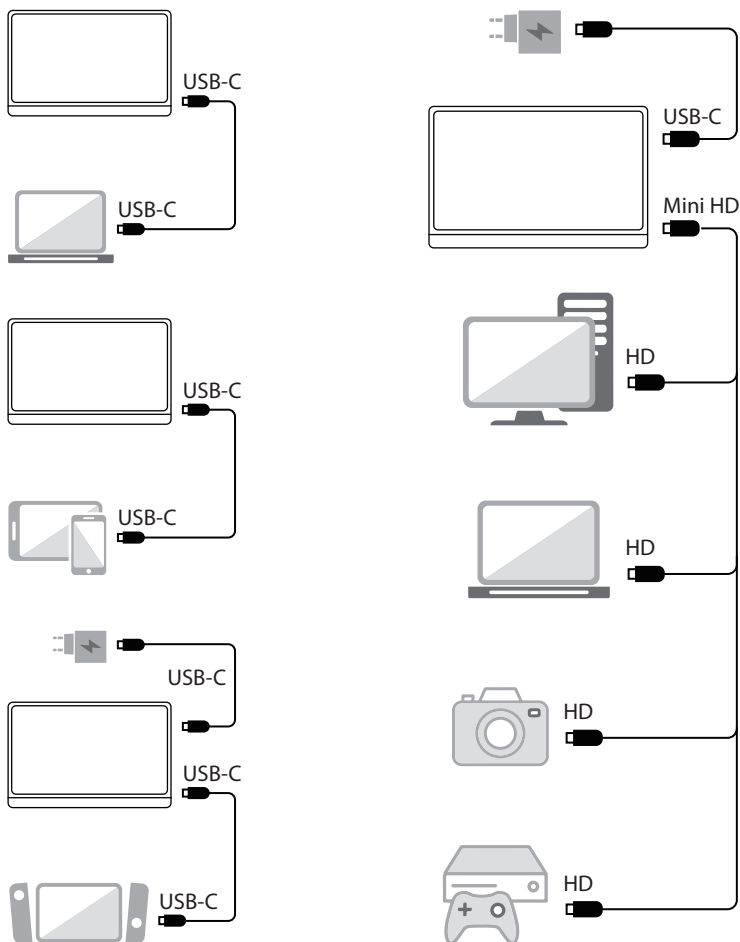

Sørg for at USB-C-porten på bærbare datamaskiner/smarttelefoner og andre enheter kan støtte minst Thunderbolt 3.0 standard når man bruker USB-C-tilkobling.

Menybeskrivelse

- Menyene på skjermen (OSD) kan brukes til å justere innstillingene til skjermen. Trykk bare én gang på rullehjulet for å få tilgang til hovedmenyen.

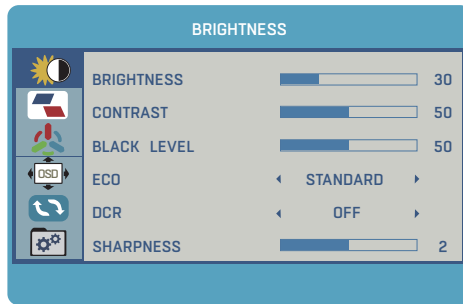

SPESIFIKASJONER

Modellnavn	CNANO185	
Panel	Skjermstørrelse	18,5"
	Lysstyrke (typisk)	250 cd/m ²
	Kontrast (typisk)	1000:1
	Oppløsning (H x V)	1920 x 1080
	Sideforhold	16:9
	Fargeområde	NTSC 72%
	Oppdateringsfrekvens	75Hz
Grensesnitt	Inngang 1	USB-C x 2
	Inngang 2	Mini HD x 1
Utgangskontakter	Øretelefon	3,5 mm øretelefon x 1
	Høytaler	1W x 2
Effekt	Forbruk	Typisk 7,5 W, maks 16 W
	Strøminngang	USB-C (DC5V/4A)
Fysisk	Mål (B*D*H)	423 x 250 x 18mm
	Nettvekt	1.13 kg (±20g)
	Bruttovekt	2 kg (±20g)
Miljøforhold	Handling	Temperatur: +5–50 °C
		Fuktighet: 20–85 %
	Oppbevaring	Temperatur: : -20–55 °C
		Fuktighet: 5–85 %



- Kast all emballasje, papir, kartonger og plastposer i samsvar med lokale regler for resirkulering.
- Når produktet ikke skal brukes lenger, må det avhendes adskilt fra husholdningsavfall hos en miljøstasjon for gjenvinning av elektrisk og elektronisk avfall.
- Du får nærmere informasjon ved å kontakte lokale myndigheter eller forhandleren du kjøpte produktet hos.

Power International AS,
Postboks Box 523, 1471 Lørenskog, Norge

Power Norge:
<https://www.power.no/kundeservice/>
T: 21 00 40 00

Expert Danmark:
<https://www.expert.dk/kundeservice/>
T: 70 70 17 07

Power Danmark:
<https://www.power.dk/kundeservice/>
T: 70 33 80 80

Punkt 1 Danmark:
<https://www.punkt1.dk/kundeservice/>
T: 70 70 17 07







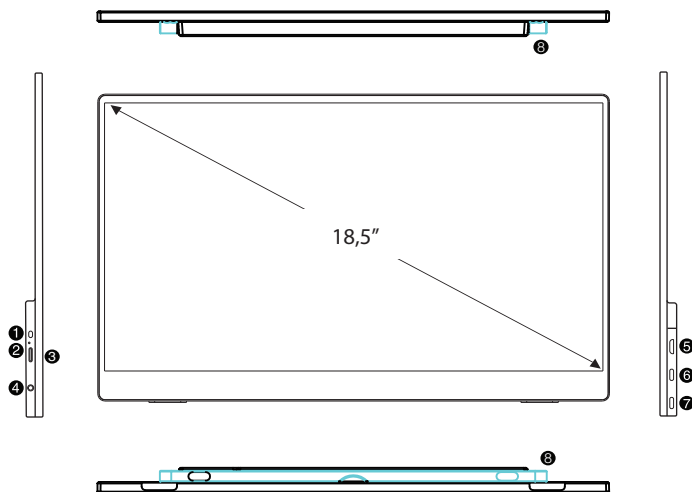

Power Finland:
<https://www.power.fi/tuki/asiakaspalvelu/>
T: 0305 0305

Power Sverige:
<https://www.power.se/kundservice/>
T: 08 517 66 000

Brug

Beskrivelse af knapperne



1		Tænd/sluk	Tænd og sluk/Retur-knap
2		Strømindikator	Strømindikator
3		Rulleknap	Menu-knap
4		3,5 mm hovedtelefonudgang	Ekstern lydстик, headset
5		Mini HD-indgang	Mini HD-dataстик
6		USB-C-indgang	Fuld funktionel USB-C-port
7		USB-C-indgang	Fuld funktionel USB-C-port
8		Understøttelse	160° drejning

Justering af skærmen

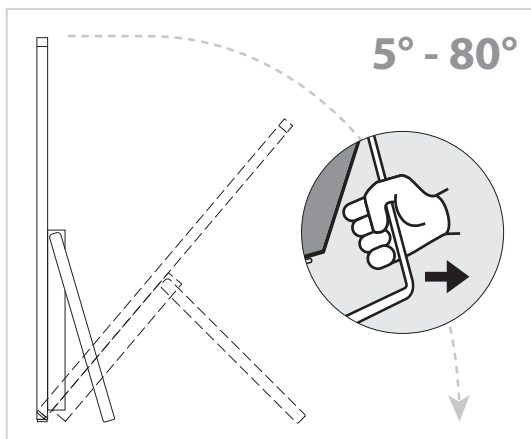

BEMÆRK: Pas på dine fingre, når du justerer skærmen, så de ikke kommer i klemme.

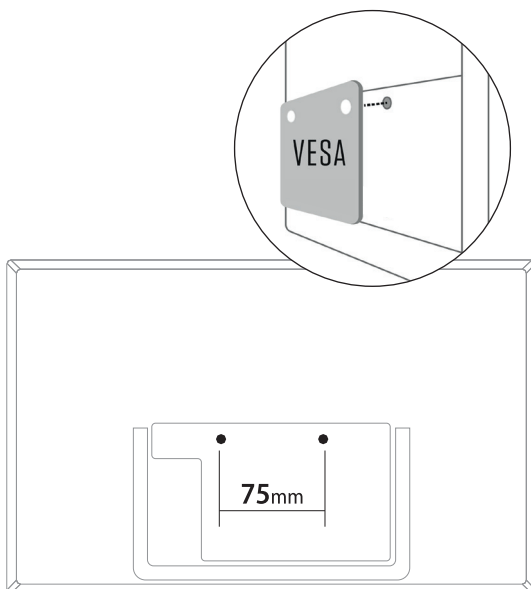

Produktintroduktion

Pakkens indhold



Skærm

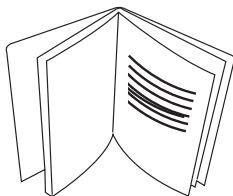

Brugsvejledning

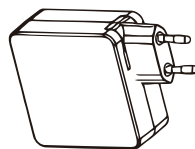

5V - 4A adapter

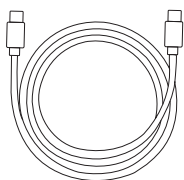

USB-C-kabel

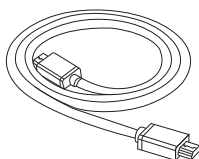











Mini HD til HD-kabel

TILSLUTNING OG STRØMFORSYNING

Tilslutning

Nogle bærbare computere forsyner muligvis ikke nok strøm til skærmen. Se, om USB-C-porten på din bærbare computer har symbolerne, der står tabellen nedenfor. Hvis et af de grønne afkrydsede symboler er på computer, kan USB-C-porten forsyne data og nok strøm til skærmen. Bemærk, MacBook-porte er kompatible, selvom der ikke er nogen symboler.

	✓		✓
	✓		✓
	✓	Alle bærbare computere fra Apple er kompatible	✓

	✗		✗
	✗		✗
	✗		✗

TILSLUTNING OG STRØMFORSYNING

VIGTIGT: Skærmen kan forbindes til enheder via forskellige signaltransmissionsfunktioner, som bruger en strømkilde på 5V/4A.

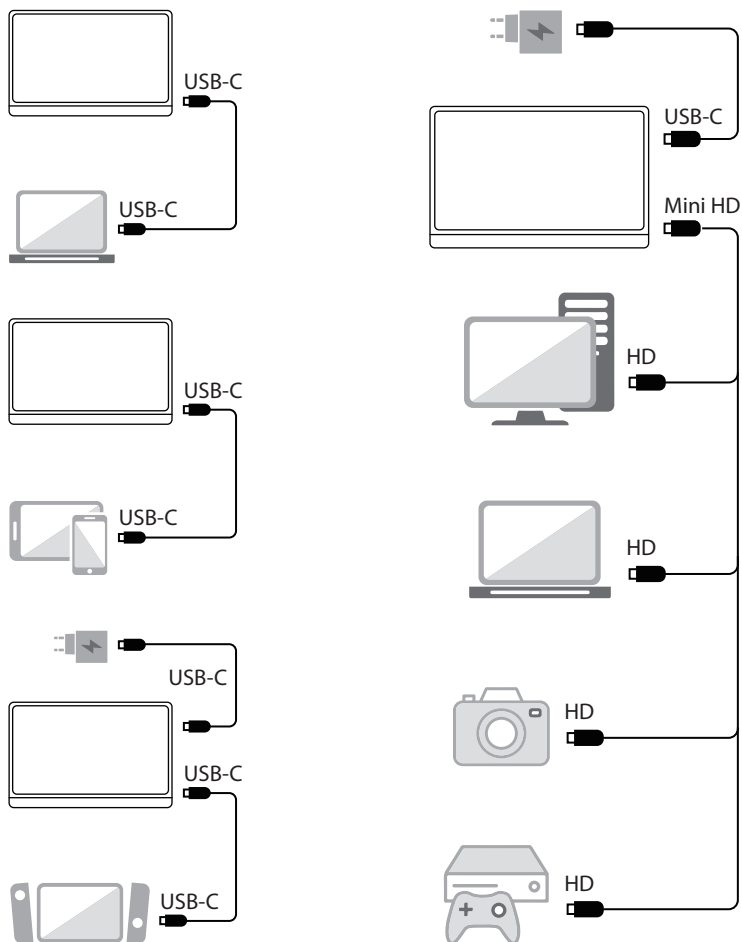

Sørg for, at USB-C-porten på din bærbare computer/mobiltelefon og andre enheder kan bruges med mindst Thunderbolt 3.0 standarden, hvis du bruger USB-C-forbindelsen.

Menubeskrivelse

- Skærmmenuen (OSD) bruges til at konfigurere skærmens indstillinger. Hovedmenuen åbnes ved blot at trykke én gang på rullehjulet.

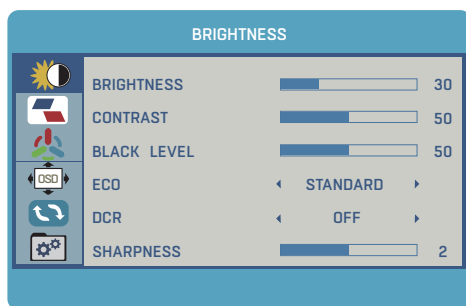

SPECIFIKATIONER

Modelnavn	CNANO185	
Skærm	Skærmstørrelse	18,5"
	Lysstyrke (typisk)	250cd/m2
	Kontrast (typisk)	1000:1
	Opløsning (H x V)	1920 x 1080
	Billedforhold	16:9
	Farveskala	NTSC 72%
	Opdateringshastighed	75Hz
Grænseflade	Indgang 1	USB-C x 2
	Indgang 2	Mini HD x 1
Udgangsstik	Hovedtelefonstik	3,5 mm hovedtelefonstik x 1
	Højtaler	1W x 2
Effekt	Forbrug	Typisk 7,5 W, maks. 16 W
	Strømindgang	USB-C (jævnstrøm (DC) 5V/4A)
Fysisk	Mål (B x D x H)	423 x 250 x 18mm
	Nettovægt	1,13 KG (±20 g)
	Bruttovægt	2 KG (±20 g)
Miljøbetingelser	Handling	Temperatur: 5°C ~ 50°C
		Luftfugtighed: 20% ~ 85%
	Opbevaring	Temperatur: -20°C ~ 55°C
		Luftfugtighed: 5% ~ 85%



- Bortskaf alt emballage, papir, kartoner og plastposer i overensstemmelse med dine lokale genbrugsbestemmelser.
- Ved slutningen af produktets levetid, skal det bortskaffes separat fra dit husholdningsaffald på et godkendt genbrugsplads.
- Kontakt de lokale myndigheder eller forhandleren for yderligere oplysninger.

Power International AS,
PO Box 523, 1471 Lørenskog, Norway

Power Norge:
<https://www.power.no/kundeservice/>
T: 21 00 40 00

Expert Danmark:
<https://www.expert.dk/kundeservice/>
T: 70 70 17 07

Power Danmark:
<https://www.power.dk/kundeservice/>
T: 70 33 80 80

Punkt 1 Danmark:
<https://www.punkt1.dk/kundeservice/>
T: 70 70 17 07

Power Finland:
<https://www.power.fi/tuki/asiakaspalvelu/>
T: 0305 0305

Power Sverige:
<https://www.power.se/kundservice/>
T: 08 517 66 000

Käyttö

Painikkeiden kuvaus

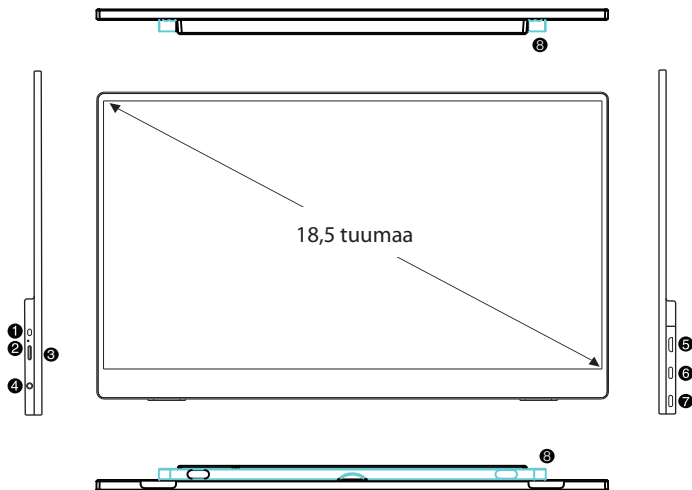

1		Päälle/pois	Virta päälle ja pois päältä / Palautuspainike
2		LED-virran merkkivalo	Virtavalo
3		Vierityspyörä	Valikkopainike
4		3,5mm kuulokkeiden lähtö	Ulkoinen ääniliitin, kuulokkeet
5		Mini HD-tulo	Mini HD-tyypin dataliitin
6		USB-C-tulo	Täysin toimiva USB-C-portti
7		USB-C-tulo	Täysin toimiva USB-C-portti
8		Tuki	160° Kierto Kara

Näytön säätäminen

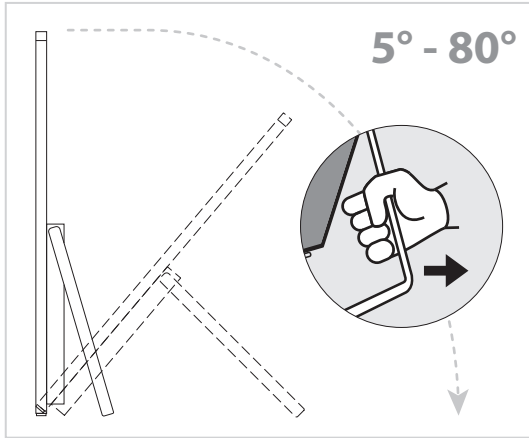

HUOM: Ole tarkkana sormiesi sijoittelussa, kun säädät monitorin katselukulmaa, jotta vältät loukkaantumiset.

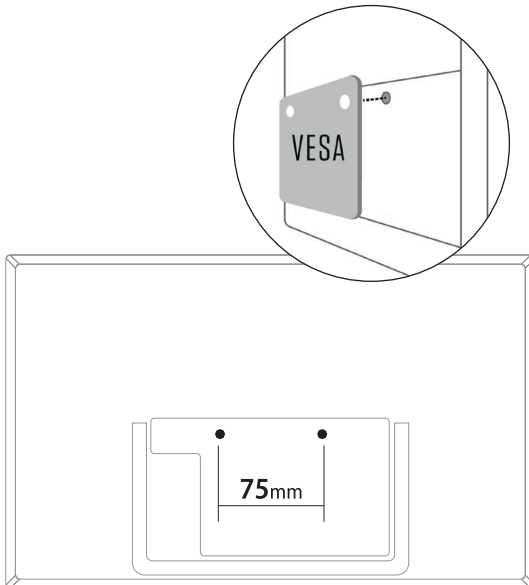

Tuotteen esittely**Pakkausluettelo**

Näyttöruutu

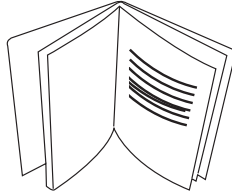

Käyttöopas

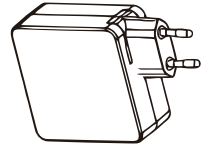

5V - 4A -sovitin

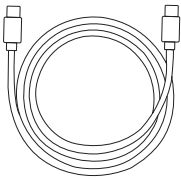

USB-C-kaapeli

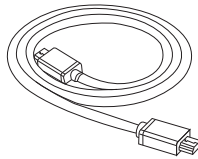











Mini HD-HD-kaapeli

LIITÄNTÄ JA VIRRANSYÖTTÖ

Liitinosa

Jotkin kannettavat tietokoneet eivät ehkä anna riittävästi virtaa näytölle. Tarkista, onko kannettavan tietokoneen USB-C-portissa alla olevassa taulukossa esitettyjä symboleja. Jos sinulla on jokin vihreistä ruksatuista symboleista, USB-C-porttisi tuottaa dataa ja riittävästi virtaa näytölle. Huomaa, että MacBookin portit ovat yhteensopivia, vaikka niiden vieressä ei olisikaan symboleja.

	✓		✓
	✓		✓
	✓	Kaikki Applen kannettavat tietokoneet ovat yhteensopivia	✓

	✗		✗
	✗		✗
	✗		✗

LIITÄNTÄ JA VIRRANSYÖTTÖ

HUOMIO: Näyttö voidaan liittää laitteisiin eri signaalinsiirtotilojen kautta, ja siihen tarvitaan

5V/4A:n virtalähde.

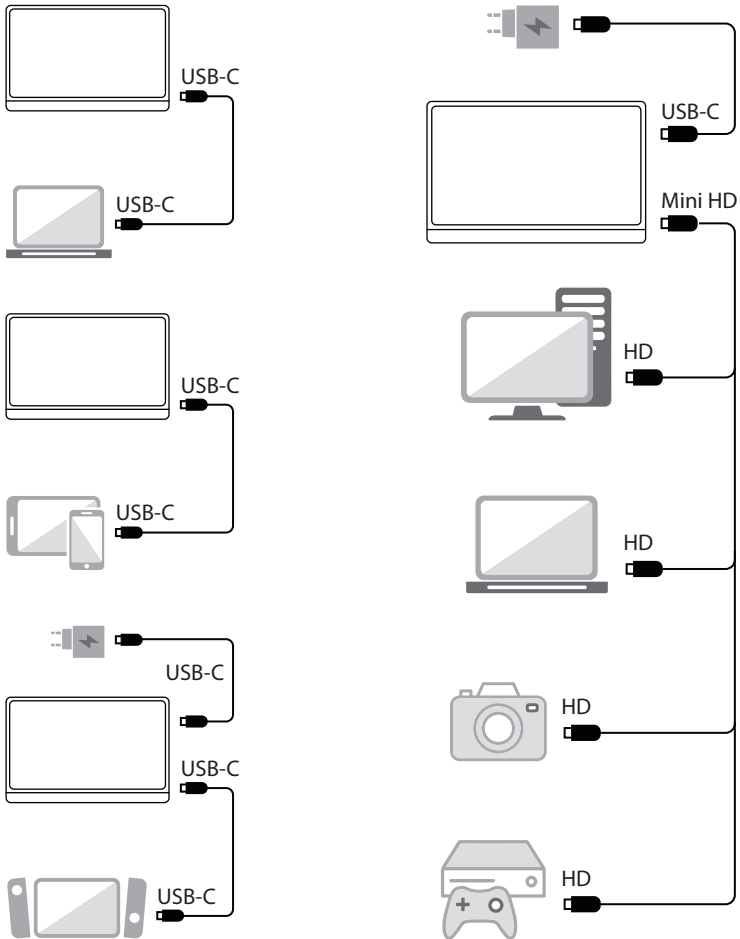

Varmista, että kannettavien tietokoneiden/älypuhelimien ja muiden laitteiden USB-C-portti tukee vähintään Thunderbolt 3.0 -standardia, kun käytät USB-C-liitäntää.

OSD-VALIKKO

Valikon kuvaus

- Näytön näyttövalikon (OSD) avulla voit säätää monitorin asetuksia. Pääset päävalikkoon painamalla vierityspyörää kerran.

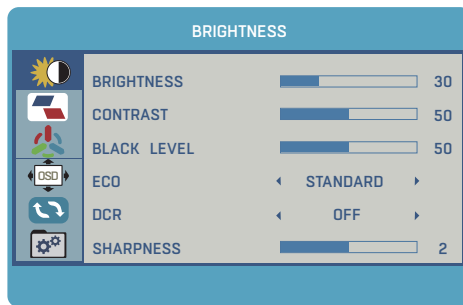

TEKNISET TIEDOT

Mallin nimi	CNANO185	
Paneeli	Näytön koko	18,5"
	Kirkkaus (tyypillinen)	250cd/m2
	Kontrasti (tyypillinen)	1000:1
	Resoluutio (H x V)	1920 x 1080
	Kuvasuhde	16:9
	Väriskaala	NTSC 72%
	Päivitysnopeus	75Hz
Liitäntä	Tulo 1	USB-C x 2
	Tulo 2	Mini HD x 1
Lähtöliitin	Kuulokkeet	3,5mm kuulokkeet x 1
	Kaiutin	1W x 2
Teho	Kulutus	Tyypillinen 7,5W, Max 16W
	Virtatulo	USB-C (DC5V/4A)
Fyysinen	Mitat (L*S*K)	423 x 250 x 18mm
	Nettopaino	1,13 Kg (±20g)
	Bruttopaino	2 Kg (±20g)
Ympäristöolosuhteet	Toiminto	Lämpötila: 5 ~ 50°C
		Kosteus: 20 ~ 85 %
	Säilytys	Lämpötila: -20 ~ 55 °C
		Kosteus: 5 ~ 85%



- Hävitä kaikki pakkausmateriaali, paperi, pahvilaatitot ja muovipussit paikallisten kierrätysäädösten mukaisesti.

- Hävitä elinkaarensa päässä oleva tuote erillään kotitalousjätteestä valtuutetussa kotitalouden WEEE-jätteenkierrätyskeskuksessa.

- Jos haluat lisätietoja, ota yhteys paikallisiin viranomaisiin tai tuotteen myyneeseen liikkeeseen.

Power International AS,
PO Box 523, 1471 Lørenskog, Norway

Power Norjassa:
<https://www.power.no/kundeservice/>
P: 21 00 40 00

Expert Tanskassa:
<https://www.expert.dk/kundeservice/>
P: 70 70 17 07

Power Tanskassa:
<https://www.power.dk/kundeservice/>
P: 70 33 80 80

Punkt 1 Tanskassa:
<https://www.punkt1.dk/kundeservice/>
P: 70 70 17 07

Power Suomessa:
<https://www.power.fi/tuki/asiakaspalvelu/>
P: 0305 0305

Power Ruotsissa:
<https://www.power.se/kundsservice/>
P: 08 517 66 000

Användning

Beskrivning av knappar

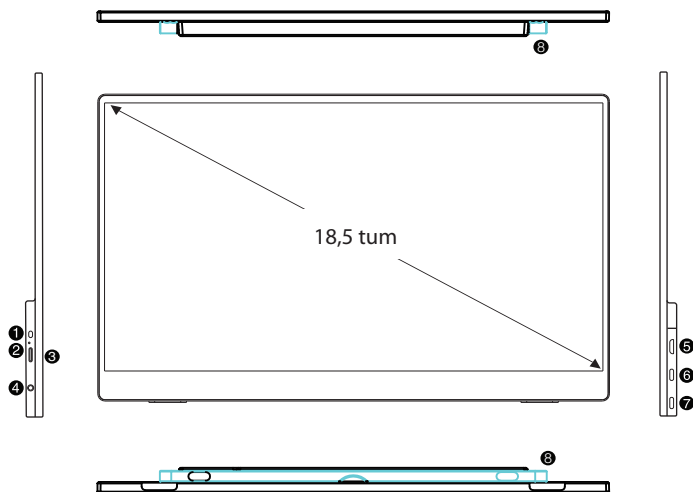

1		På/av	Ström på och av / Returknapp
2		LED-strömindikator	Strömlampa
3		Rullhjul	Menyknapp
4		3,5 mm hörlursutgång	Extern ljudkontakt, headset
5		Mini HD-ingång	Dataanslutning av mini HD-typ
6		USB-C-ingång	USB-C-port med full funktion
7		USB-C-ingång	USB-C-port med full funktion
8		Stöd	160° vridbar axel

Justera bildskärmen

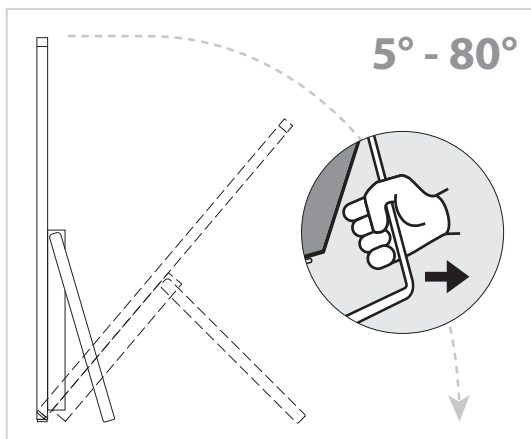

OBS! Var uppmärksam på hur du placerar fingrarna när du justerar bildskärmens betraktningvinkel för att undvika skador.

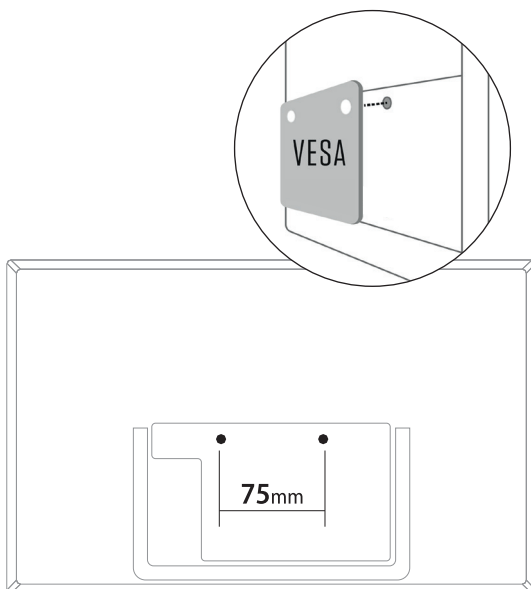

Produktpresentation

Innehåll i förpackningen



Bildskärm

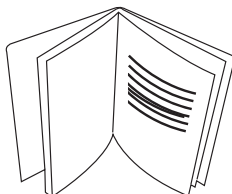

Användarmanual

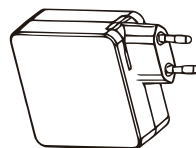

5V - 4A adapter

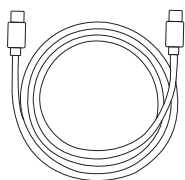

USB-C-kabel

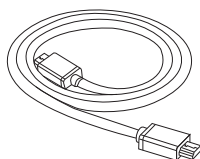











Mini HD till HD-kabel

ANSLUTNING OCH STRÖMFÖRSÖRJNING

Inkoppling

Vissa bärbara datorer kanske inte ger tillräckligt med ström till bildskärmen. Kontrollera om USB-C-porten på din bärbara dator innehåller symbolerna i tabellen nedan. Om du har en av de grönmarkerade symbolerna kommer din USB-C-port att leverera data och tillräckligt med ström till skärmen. Observera att MacBook-portar är kompatibla även om det inte finns några symboler bredvid dem.

	✓		✓
	✓		✓
	✓	Alla bärbara datorer från Apple är kompatibla	✓

	✗		✗
	✗		✗
	✗		✗

ANSLUTNING OCH STRÖMFÖRSÖRJNING

OBS! Skärmen kan anslutas till enheter via olika signalöverföringslägen, vilket kräver en strömkälla på 5V/4A.

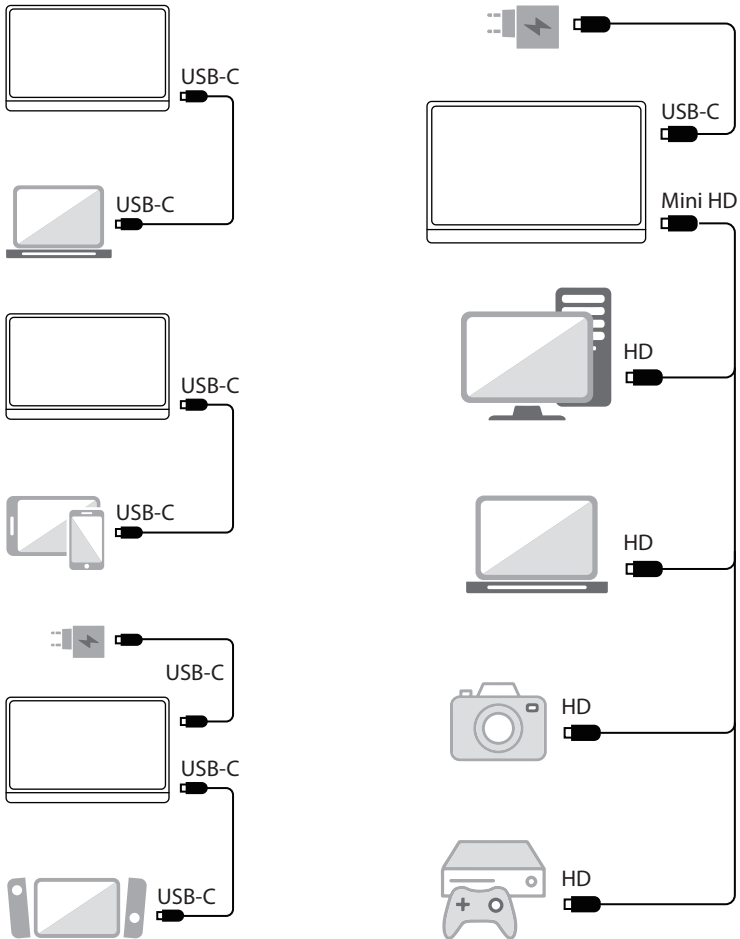

Kontrollera att USB-C-porten på dina bärbara datorer/smartphones och andra enheter har stöd för minst Thunderbolt 3.0-standarden när du använder USB-C-anslutning.

Beskrivning av meny

- OSD-meny (On-Screen Display) kan användas för att justera bildskärmens inställningar. För att komma till huvudmenyn trycker du en gång på skrollhjulet.

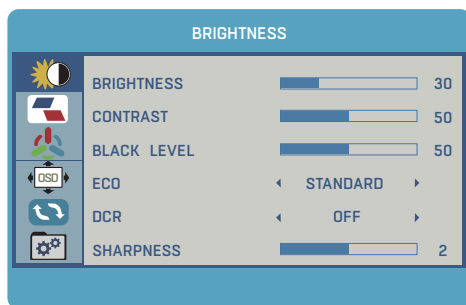

SPECIFIKATIONER

Modellnamn	CNANO185	
Panel	Skärmens storlek	18,5"
	Ljusstyrka (normalt)	250cd/m2
	Kontrast (normalt)	1000:1
	Upplösning (H x V)	1920 x 1080
	Bildförhållande	16:9
	Färgomfång	NTSC 72%
	Uppdateringsfrekvens	75Hz
Gränssnitt	Ingång 1	USB-C x 2
	Ingång 2	Mini HD x 1
Utgångsterminal	Hörlurar	3,5 mm hörlurar x 1
	Höjttaler	1W x 2
Effekt	Förbrukning	Normalt 7,5 W, max 16 W
	Inström	USB-C (DC5V/4A)
Fysiskt	Mått (B*D*H)	423 x 250 x 18 mm
	Nettovikt	1,13 KG (±20g)
	Bruttovikt	2 KG (±20g)
Miljöförhållanden	Åtgärd	Temperatur: 5°C ~ 50°C
		Luftfuktighet: 20% ~ 85%
	Förvaring	Temperatur: -20°C ~ 55°C
		Luftfuktighet: 5% ~ 85%



- Kasta emballage, papper, kartong och plastpåsar i enlighet med de lokala reglerna för återvinning.
- Kasta inte apparaten bland hushållsavfall när den är uttjänt, utan lämna in den på en auktoriserad återvinningsstation för e-avfall.
- För ytterligare information, kontakta din kommun eller din återförsäljare där du köpte apparaten.

Power International AS,
PO Box 523, N-1471 Lørenskog, Norge

Power Norge:
<https://www.power.no/kundeservice/>
T: 21 00 40 00

Expert Danmark:
<https://www.expert.dk/kundeservice/>
T: 70 70 17 07

Power Danmark:
<https://www.power.dk/kundeservice/>
T: 70 33 80 80

Punkt 1 Danmark:
<https://www.punkt1.dk/kundeservice/>
T: 70 70 17 07

Power Finland:
<https://www.power.fi/tuki/asiakaspalvelu/>
T: 0305 0305

Power Sverige:
<https://www.power.se/kundeservice/>
T: 08 517 66 000

