

CEPTER

USER MANUAL
49" Curved Monitor

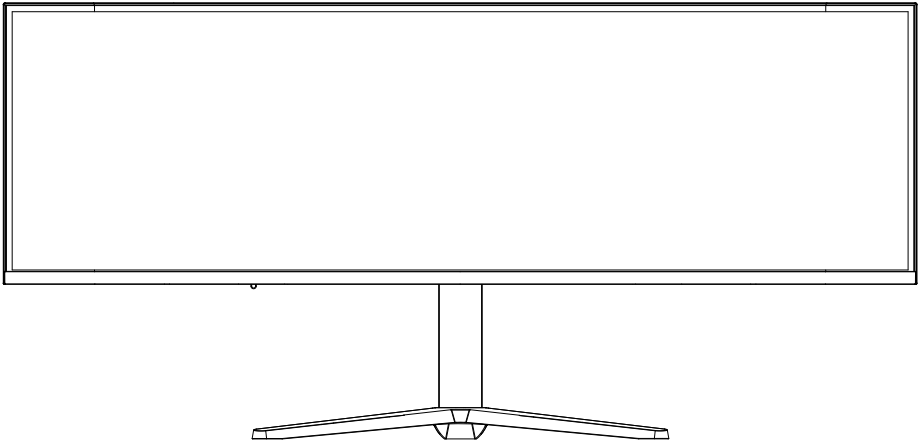

C49ATILIUS2

www.ceptertech.com

GB

Thank you for choosing this Monitor.

Please read this instruction manual thoroughly before using and ensure you are familiar with the setup and operation of your new gaming gadget. Retain this instruction manual for future reference.

NO

Takk for at du valgte denne Monitoren.

Les denne bruksanvisningen nøye før bruk, og sørg for at du er kjent med oppsett og bruk av ditt nye spilltilbehør.

Ta vare på denne bruksanvisningen for fremtidig referanse.

DK

Tak, for at dit valg af dette Skærm.

Læs venligst denne brugsanvisning grundigt inden brug, og sørg for, at du er bekendt med opsætningen og driften af din nye spille-enhed.

Behold denne brugsanvisning til senere brug.

FI

Kiitos, kun valitsit tämän monitori.

Lue nämä käyttöohjeet perusteellisesti ennen käyttöä ja varmista, että olet tutustunut uuden pelilaitteesi asettamiseen ja käyttöön.

Säilytä tämä käyttöopas tulevaa tarvetta varten.

SE

Tack för att du valt denna skärm.

Läs noggrant bruksanvisningen innan du använder spelenheten, för att se till att du har kunskap om dess inställningar och funktioner.

Spara bruksanvisningen för framtida referens.

Instruction Manual – English	page	3 - 10
Bruksanvisning – Norsk	side	11 - 18
Brugervejledning – Dansk	side	19 - 26
Käyttöopas - Suomi	sivu	27 - 34
Bruksanvisning – Svenska	sida	35 - 42

EN

NO

DK

FI

SE

Product introduction

Packing list



Monitor



Stand



Base



User Manual

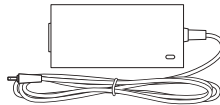

Power Adapter

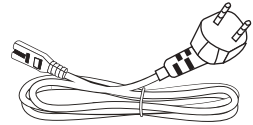

Power Cable

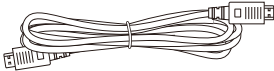

DP Cable

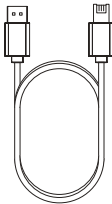

USB-A to B Cable

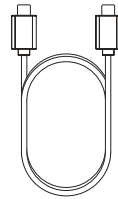

USB-C Cable

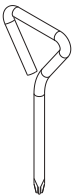

Screwdriver

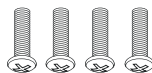

Screws x 4

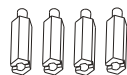

Mount Screws x 4

- Redundant screws can be used as spare screws.

Installation**Installation of base**

1



2

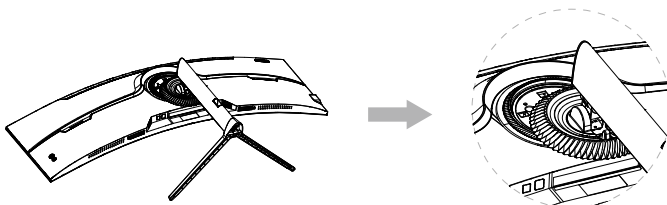

3

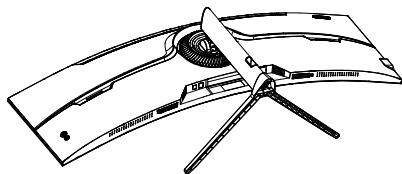

4

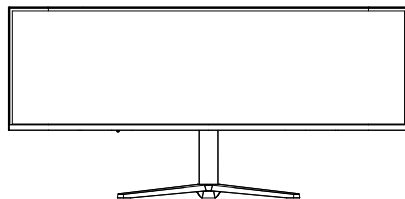

 **Note:** While setting up the monitor, do not press the liquid crystal screen to avoid damage.

Installation

Installation of mount

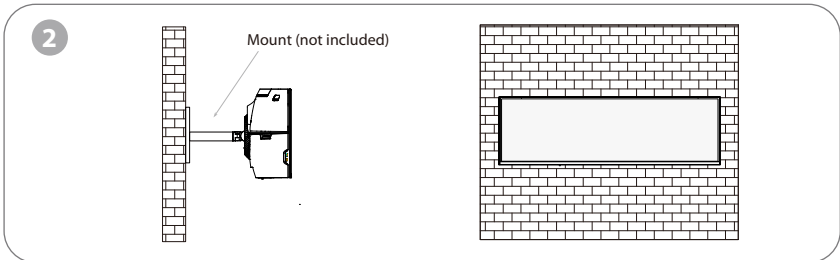
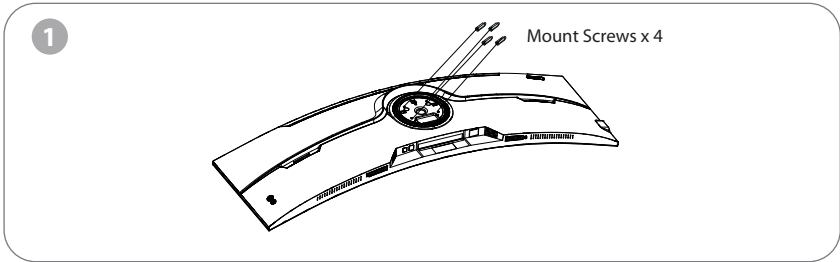

During installation, do not pinch the screen to avoid damage. Refer to the user manual of the separately purchased wall mount for installation instructions.

Tip: The mounting hole distance for this product is 75x75 mm.

⚠ Note: To prevent the monitor from falling, install it securely and ensure full protection. Do not place or hang objects on the wall mount, and the mount's height should be less than 2 meters.

Adjusting the monitor

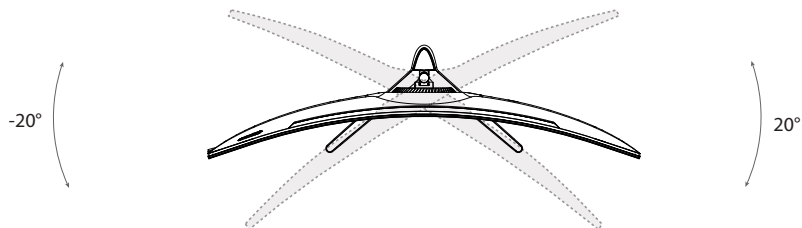

Rotation angle
-20°, +20°

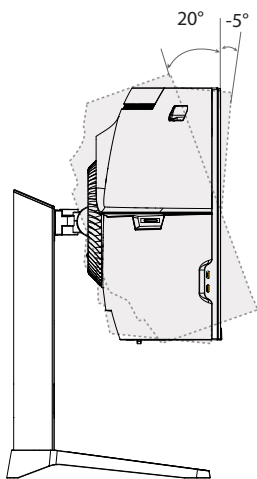

Tilting angle
-5°, +20°

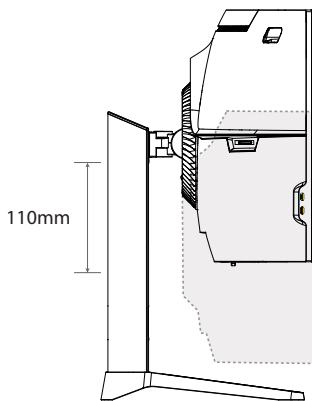



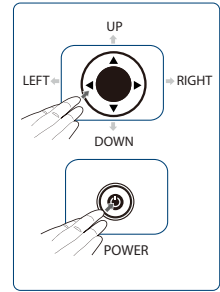
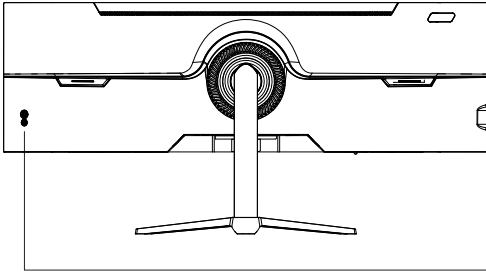

Height Adjustment
110mm

Usage

Description of buttons



Monitor Button

Monitor Button	Action
 POWER	Click the Power button to turn on the monitor.
 UP	Allows for the volume adjustment.
 DOWN	Cross Aiming Shortcut Button (During Gameplay).
 LEFT	Allows for the selection of signal source or exit the OSD menu.
 RIGHT	Press to display OSD menu.

Explanation of indicators

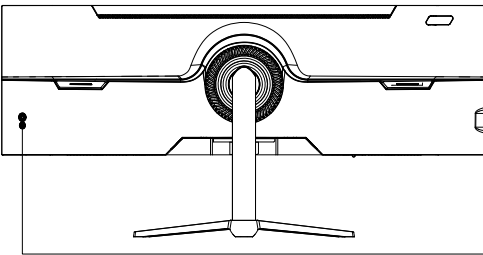

Indicator

Indicator: Steady blue light indicates the power is on and the monitor runs normally. Please make sure that your computer is turned on and all video cables are fully plugged in and/or connected.

OSD menu

Menu description

- The color and shape of the OSD menu of the actual monitor may be slightly different from them shown in the figure.
 - Specifications of the OSD menu may change with improvements of functions without prior notice.
- The on-screen display (OSD) menu can be used to adjust the settings of the monitor and is displayed on the screen after turning on the monitor and pressing the ► button.

1. Press ► to enter the OSD screen.

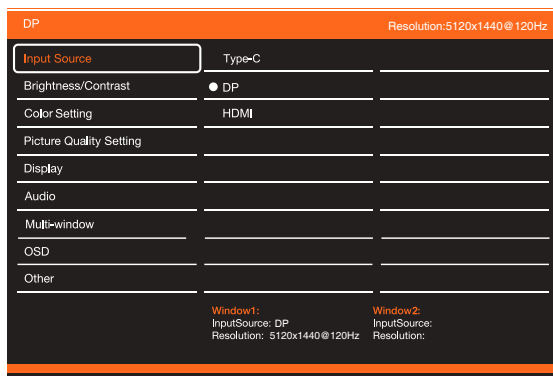

2. Press ▼ or ▲ to browse through the functions.

-Select the desired function, then press the ► button to enter the submenu.

-Press ▼ or ▲ to browse the sub-menus, and then press the ► key to confirm the selection of the desired function.

-Press ▼ or ▲ to select an option, then press ► to confirm the setting and exit the current menu.

3. Press ◀ to exit the menu interface.

Specification

Product model		C49ATILIUS2
Screen Size		49" (124cm)
Aspect Ratio		32:9
Viewing Angle		178°(H) / 178°(V)
Pixel pitch		0.2328 (H) × 0.2328 (V) mm
Contrast ratio		3000:1(TYP)
Colors		16.7M (8 bit)
Resolution		5120x1440
Maximum refresh rate		120Hz
Power type		DC24V,5A
Ports		HDMI + DP+USB-C+USB-B+USB-Ax2 + Audio Out
Product Dimensions	Without base	1185.64 x 192.44 x 365.53 mm
	Lifting base With base	1185.64 x 295.21 x 566.08 mm
Tilting angle		Forward tilting : 5°; Backward tilting: 20°
Height range		110mm
Rotation angle		-20°, +20°
Speaker		2x3W
Net Weight		7.8KG
Gross Weight		11.9KG
Environmental conditions	Action	Temperature: 0°C~ 40°C (32°F ~ 104°F) Humidity: 10%~90% RH (non-condensing)
	Storage	Temperature: -20°~ 60° (-4°F ~ 140°F) Humidity: 5%~95% RH (non-condensing)



The terms HDMI and HDMI High-Definition Multimedia Interface, and the HDMI Logo are trademarks or registered trademarks of HDMI Licensing Administrator, Inc. in the United States and other countries.



HDMI™
HIGH-DEFINITION MULTIMEDIA INTERFACE



-Dispose of all packaging, paper, cartons and plastic bags in accordance with your local recycling regulations.

-At the end of the product's lifespan, please dispose of it separately from your household waste at an authorized household WEEE waste recycling centre.

-For more information, please contact the local authority or the retailer where you purchased the product.

Power International AS,
PO Box 523, 1471 Lørenskog, Norway

Power Norge:
<https://www.power.no/kundeservice/>
T: 21 00 40 00

Expert Danmark:
<https://www.expert.dk/kundeservice/>
T: 70 70 17 07

Power Danmark:
<https://www.power.dk/kundeservice/>
T: 70 33 80 80

Punkt 1 Danmark:
<https://www.punkt1.dk/kundeservice/>
T: 70 70 17 07

Power Finland:
<https://www.power.fi/tuki/asiakaspalvelu/>
T: 0305 0305

Power Sverige:
<https://www.power.se/kundeservice/>
T: 08 517 66 000

Produktintroduksjon

Pakkeliste

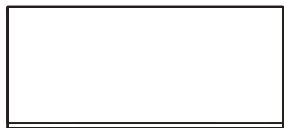

Skjerm



Gulvstativ



Sokkel



Bruksanvisning

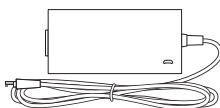

Strømadapter

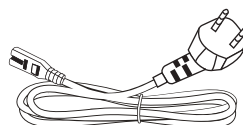

Power Cable

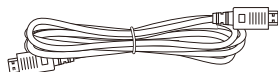

DP-kabel

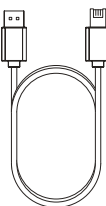

USB-A to B-kabel

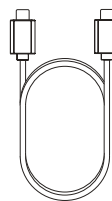

USB-C-kabel

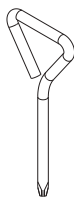

Skrutrekker

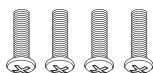

Skruer x 4

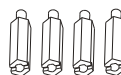

Festeskruer x 4

- Skruer som er til overs kan brukes som reserveskruer.

Installasjon

Montere sokkelen

1

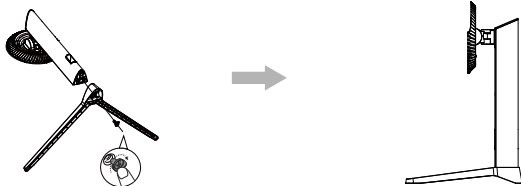

2

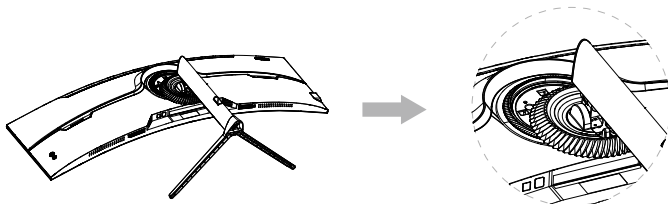

3

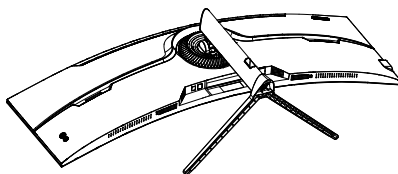

4

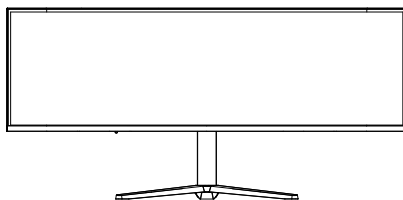

⚠ Merk: Når du setter opp skjermen, må du ikke trykke på LCD-skjermen for å unngå skade.

Installasjon

Montere feste

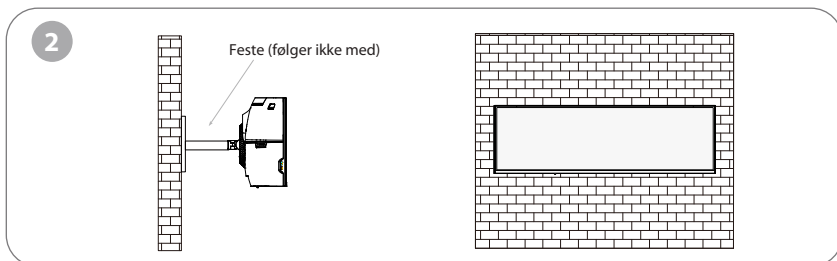
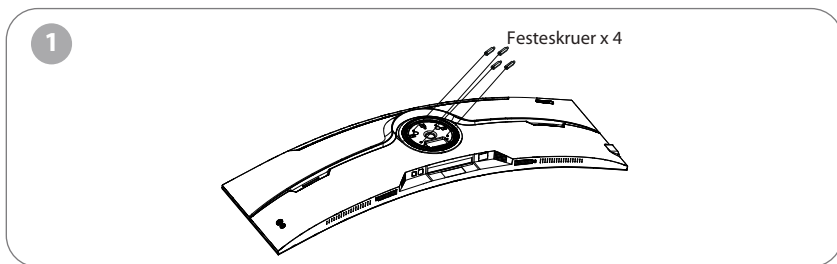

Under installasjonen, klem ikke skjermen for å unngå skade. Se i bruksanvisningen for den separat kjøpte veggfesten for installasjonsinstruksjoner.

Tips: Monteringshullavstanden for dette produktet er 75x75 mm.

⚠ Merk: For å forhindre at skjermen faller, monter den sikkert og sørg for full beskyttelse. Ikke plasser eller heng objekter på festet, og festet skal være under 2 meter høyt.

Justere skjermen

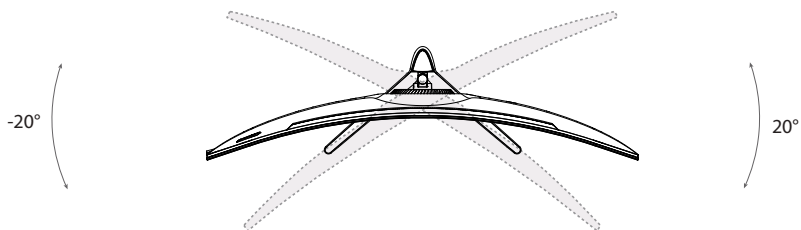

Rotasjonsvinkel
-20°, +20°

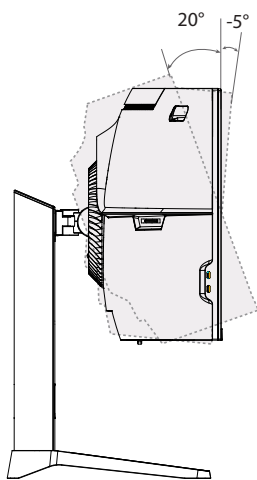

Skråstilling vinkel
-5°, +20°

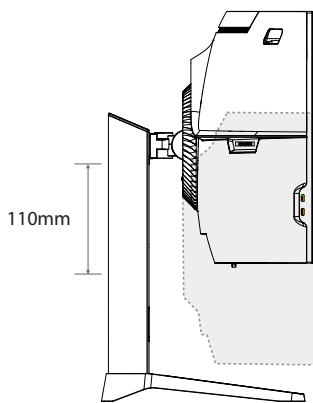

Høydeområde
110mm

Bruk

Beskrivelse av knapper

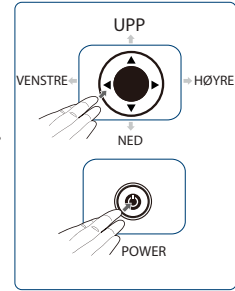
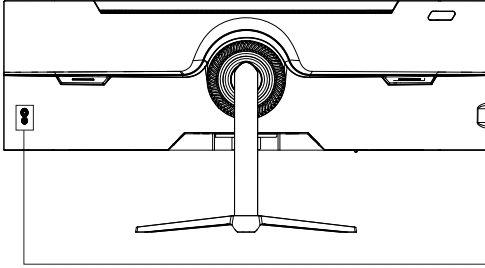

Monitor Button

Action



POWER

Klikk på strømknappen for å slå på skjermen.



UPP

Tillater justering av lydnivå.



NED

Snarveisknapp for kryssikting (Under spilling).



VENSTRE

Tillater valg av signalkilde eller avslutt OSD -menyen.



HØYRE

Trykk for å vise OSD -meny.

Monitor Button

Forklaring av indikatorer

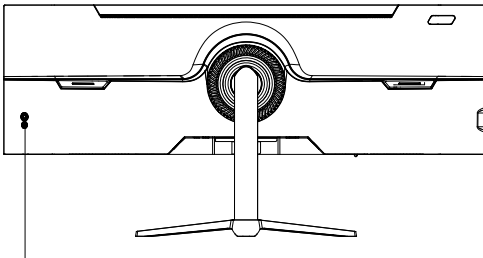

Indikator

Indikator: Konstant blått lys indikerer at strømmen er på og skjermen kjører som normalt. Sørg for at datamaskinen er slått på og at alle videokabler er plugget inn og/eller tilkoblet.

Skjermmeny

Menybeskrivelse

- Fargen og formen på skjermmenyen til den faktiske skjermen kan være litt forskjellig fra det som vises på guren.
- Spesi kasjoner for skjermmenyen kan endres med forbedringer av funksjoner uten forvarsel.

På skjermmenyen kan man justere innstillingene på skjermen. Den vises på skjermen når man har slått på skjermen og trykket ► knappen.

1. Trykk ► for å gå inn i skjermmenyen.

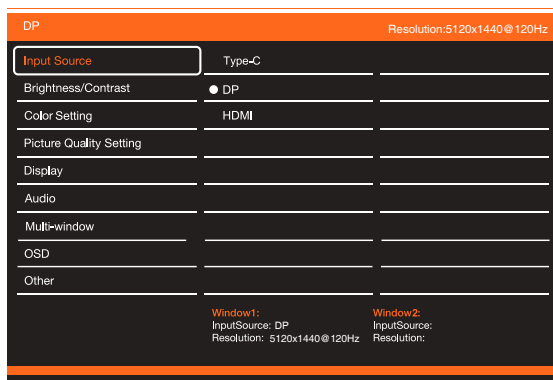

2. Trykk ▼ eller ▲ for å bla gjennom funksjonene.

- Velg ønsket funksjon, og trykk deretter ► knappen for å gå inn i undermenyen.
- Trykk ▼ eller ▲ for å bla gjennom undermenyene, og trykk deretter ► knappen for å bekrefte valget av ønsket funksjon.
- Trykk ▼ eller ▲ for å velge et alternativ, og trykk deretter ► for å bekrefte innstillingen og gå ut av gjeldende meny.

3. Trykk ◀ for å gå ut av menygrensesnittet.

Spesifikasjoner

Produktmodell		C49ATILIU52
Skjermstørrelse		49" (124cm)
Sideforhold		32:9
Betrakningsvinkel		178° (H) / 178° (V)
Pikselavstand		0.2328 (H) × 0.2328 (V) mm
Kontrastforhold		3000:1(TYP)
Farger		16.7M (8 bit)
Oppløsning		5120x1440
Maksimal oppdateringsfrekvens		120Hz
Strømtype		24V, 5A likestrøm
Porter		HDMI + DP+USB-C+USB-B+USB-Ax2 + lyd ut
Produktets mål	Uten sokkel	1185.64 x 192.44 x 365.33 mm
	Løftesokkel	Med sokkel
Skråstillingsvinkel		Vipping forover: 5°; Vipping bakover: 20°
Høydeområde		110 mm
Rotasjonsvinkel		-20°, +20°
Høytaler		2x3W
Nettovekt		7.8KG
Bruttovekt		11.9KG
Miljøforhold	Handling	Temperatur: 0–40 °C (32–104 °F) Fuktighet: 10–90 % RF (ikke-kondenserende)
	Oppbevaring	Temperatur: -20–60 °C (-4–140 °F) Fuktighet: 5–95 % RF (ikke-kondenserende)



Begrepene HDMI og HDMI High-Definition Multimedia Interface, samt HDMI-logoen, er varemerker eller registrerte varemerker for HDMI Licensing Administrator, Inc., i USA og i andre land.



HDMITM
HIGH-DEFINITION MULTIMEDIA INTERFACE



- Kast all emballasje, papir, kartonger og plastposer i samsvar med lokale regler for resirkulering.
- Når produktet ikke skal brukes lenger, må det avhendes adskilt fra husholdningsavfall hos en miljøstasjon for gjenvinning av elektrisk og elektronisk avfall.
- Du får nærmere informasjon ved å kontakte lokale myndigheter eller forhandleren du kjøpte produktet hos.

Power International AS,
Postboks Box 523, 1471 Lørenskog, Norge

Power Norge:
<https://www.power.no/kundeservice/>
T: 21 00 40 00

Expert Danmark:
<https://www.expert.dk/kundeservice/>
T: 70 70 17 07

Power Danmark:
<https://www.power.dk/kundeservice/>
T: 70 33 80 80

Punkt 1 Danmark:
<https://www.punkt1.dk/kundeservice/>
T: 70 70 17 07

Power Finland:
<https://www.power.fi/tuki/asiakaspalvelu/>
T: 0305 0305

Power Sverige:
<https://www.power.se/kundservice/>
T: 08 517 66 000

Produktintroduktion

Pakkens indhold



Skærm



Fod



Fod



Brugervejledning

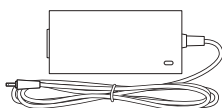

Strømadapter

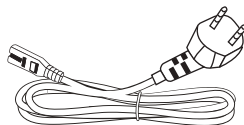

Power Cable

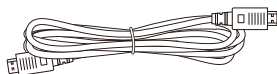

DP-kabel

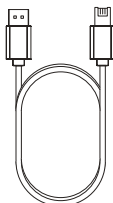

USB-A to B-kabel

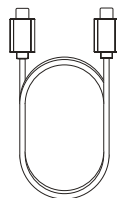

USB-C-kabel

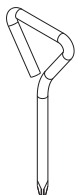

Skruetrækker

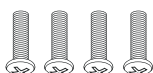

Skruer x 4

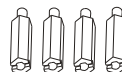

Skruer til vægmontering x 4

- Overskydende skruer kan bruges som reserveskruer.

Opstilling

Montering af foden

1

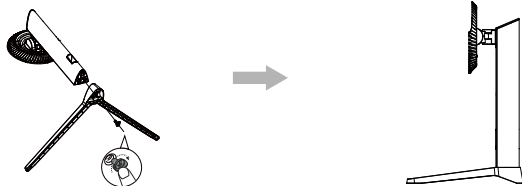

2

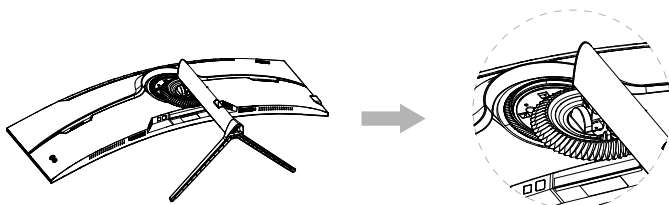

3

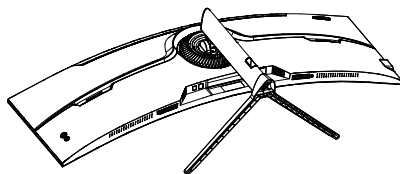

4

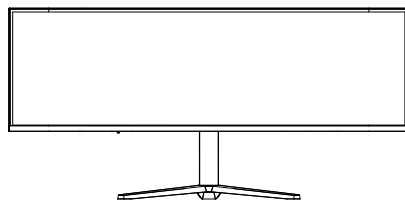

! Bemærk: Undgå at trykke på LCD-skærmen under opsætning for at undgå skader.

Opstilling

Montering af ophænget

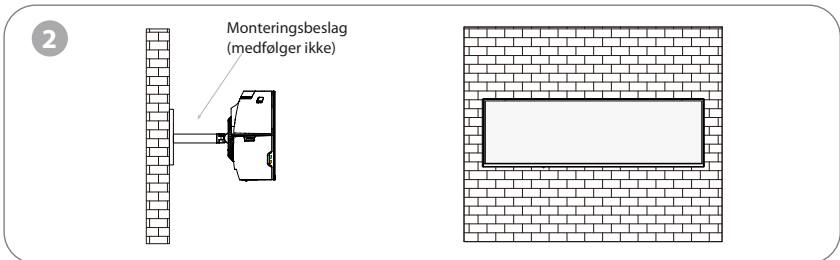
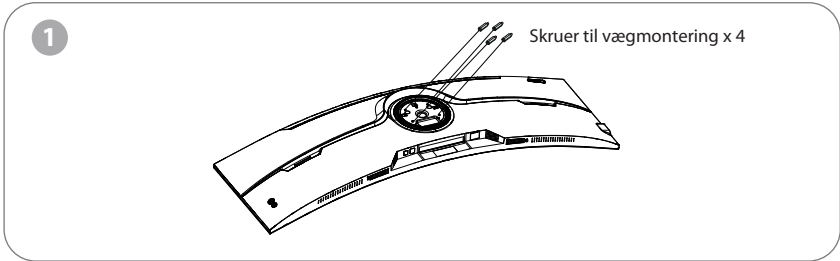

Under installationen må skærmen ikke klemmes for at undgå beskadigelse. Se brugermanualen for det separat købte vægbeslag for installationsinstruktioner.

Tip: Monteringshulafstanden for dette produkt er 75x75 mm.

⚠ Bemærk: For at forhindre, at skærmen falder, monter den sikkert og sørg for fuld beskyttelse. Placer eller hæng ikke genstande på vægbeslaget, og vægbeslagets højde bør være mindre end 2 meter.

Justering af skærmen

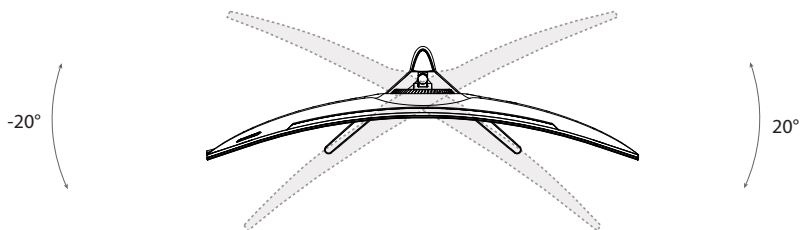

Drejevinkel
 $-20^\circ, +20^\circ$

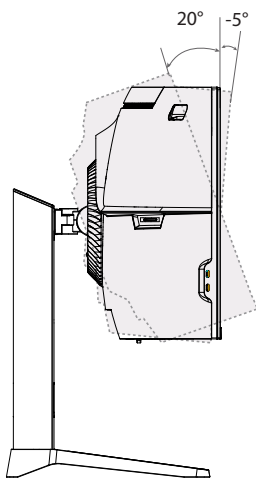

Vippevinkel
 $-5^\circ, +20^\circ$

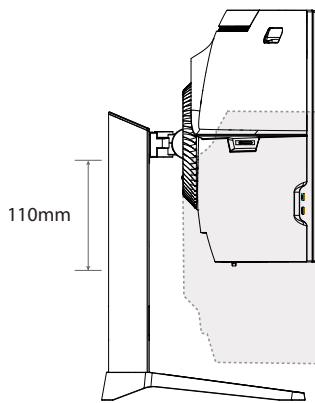



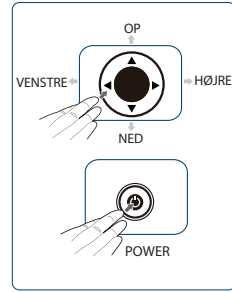
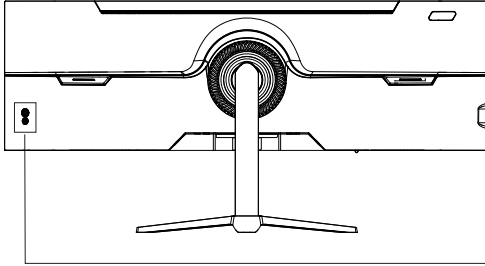

Højde Område
110mm

Brug

Beskrivelse af knapperne



Monitor Button

Monitor Button	Action
 POWER	Klik på tænd/sluk-knappen for at tænde for skærmen.
 OP	Muliggør justering af lydstyrken.
 NED	Genvejsknap til krydsretning (Under gameplay).
 VENSTRE	Tillader valg af signalkilde eller udgang af OSD -menuen.
 HØJRE	Tryk på for at vise OSD -menu.

Forklaring af indikatorerne

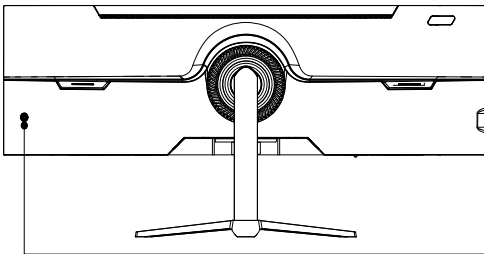

Indikator

Lysindikator: Når indikatoren lyser blå betyder det, at strømmen er tændt, og at skærmen virker normalt. Sørg for, at din computer er tændt, og at alle videokabler er forbundet ordentligt.

Skærmmenuen

Menubeskrivelse

- Farven og formen på skærmmenuen på den faktiske skærm er muligvis ikke ens med skærmen på billedet.
- Særmmenuens funktioner ændres muligvis for, at forbedre dem. Dette kan ændres uden forudgående varsel.

I skærmmenuen (OSD) kan du justere skærmens indstillinger, hvilket vises på skærmen, når den tændes og der trykkes på ► knappen.

1. Tryk ► for at åbne skærmmenuen.

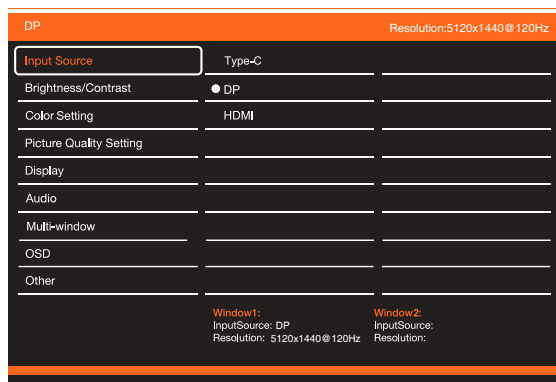

2. Brug ▼ og ▲ til, at skifte mellem punkterne.
 - Vælg det ønskede punkt, og tryk derefter på ► knappen for at åbne undermenuen.
 - Brug ▼ og ▲ til, at skifte mellem undermenuerne, og tryk derefter på M-knappen for, at bekræfte valget af det ønskede punkt.
 - Brug ▼ og ▲ til, at vælge et punkt, og tryk derefter på M for at bekræfte indstillingen og lukke den aktuelle menu.
3. Tryk på ◀ for, at lukke menuen.

Specifikationer

Produktmodel		C49ATILIUS2
Skærmstørrelse		49" (124cm)
Billedforhold		32:9
Synsvinkel		178° (H)/178° (V)
Pixelafstand		0.2328 (H) × 0.2328 (V) mm
Kontrastforhold		3000:1 (TYP)
Farver		16.7M (8 bit)
Opløsning		5120x1440
Maksimal opdateringshastighed		120Hz
Strømtype		Jævnstrøm 24V, 5A
Porte		HDMI + DP+USB-C+USB-B+USB-Ax2 + Lydudgang
Produktmål Løftebund	Uden fod	1185.64 x 192.44 x 365.53 mm
	Med fod	1185.64 x 295.21 x 566.08 mm
Hældningsvinkel		Hældning fremad: 5°; Hældning bagud: 20°
Højde Område		110 mm
Drejevinkel		-20°, +20°
Højtaler		2 x 3W
Nettovægt		7.8KG
Bruttovægt		11.9KG
Miljøbetingelser	Handling	Temperature: 0°C~ 40°C (32°F ~ 104°F) Humidity: 10%~90% RH (non-condensing)
	Opbevaring	Temperatur: -20°~ 60° (-4°F ~ 140°F) Luftfugtighed: 5~ 95 % RH (ikke-kondenserende)



Udtrykkene HDMI og HDMI High-Definition Multimedia Interface og HDMI-logoet er varemærker eller registrerede varemærker tilhørende HDMI Licensing LLC i USA og andre lande.



- Bortskaf alt emballage, papir, kartoner og plastposer i overensstemmelse med dine lokale genbrugsbestemmelser.
- Ved slutningen af produktets levetid, skal det bortskaffes separat fra dit husholdningsaffald på et godkendt genbrugsplads.
- Kontakt de lokale myndigheder eller forhandleren for yderligere oplysninger.

Power International AS,
PO Box 523, 1471 Lørenskog, Norway

Power Norge:
<https://www.power.no/kundeservice/>
T: 21 00 40 00

Expert Danmark:
<https://www.expert.dk/kundeservice/>
T: 70 70 17 07

Power Danmark:
<https://www.power.dk/kundeservice/>
T: 70 33 80 80

Punkt 1 Danmark:
<https://www.punkt1.dk/kundeservice/>
T: 70 70 17 07

Power Finland:
<https://www.power.fi/tuki/asiakaspalvelu/>
T: 0305 0305

Power Sverige:
<https://www.power.se/kundservice/>
T: 08 517 66 000

Tuotteen esittely

Pakkausluettelo



Monitori



Jalusta



Pohjaosa



Käyttöopas

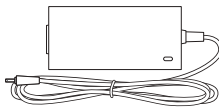

Virtasovitin

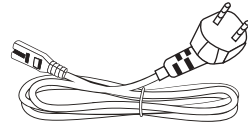

Power Cable

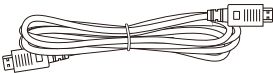

DP-kaapeli

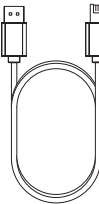

USB-A to B-kaapeli

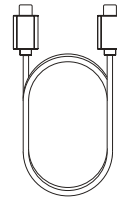

USB-C-kaapeli

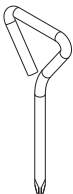

Ruuvitalta

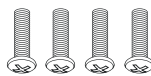

Ruuvit x 4

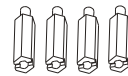

Kiinnitysruuvit x 4

- Ylimääräisiä ruuveja voidaan käyttää vararuuveina.

Asennus

Jalustan asennus

1

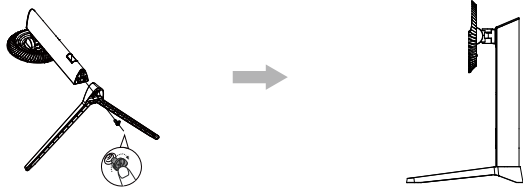

2

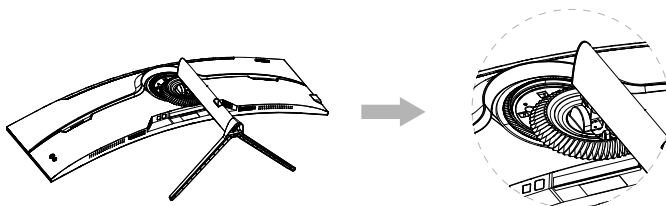

3

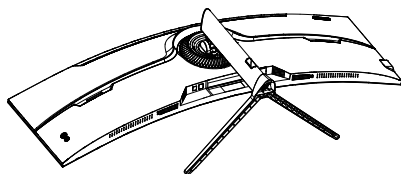

4

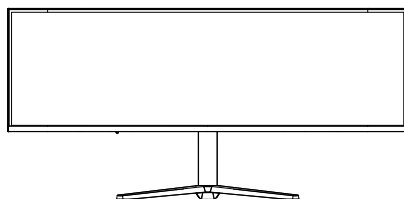

 **Huom:** Näyttöä asentaessa älä paina nestekidenäyttöä vaurioiden välttämiseksi.

Asennus

Seinätelineen asennus

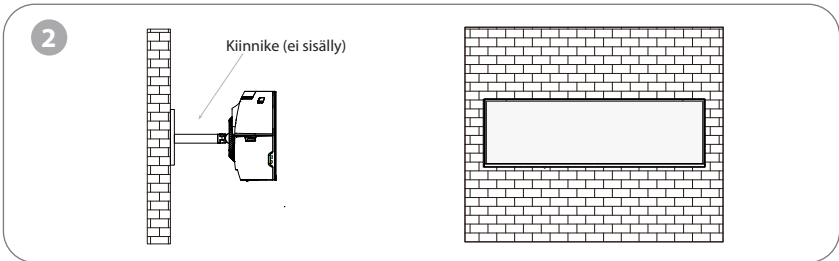
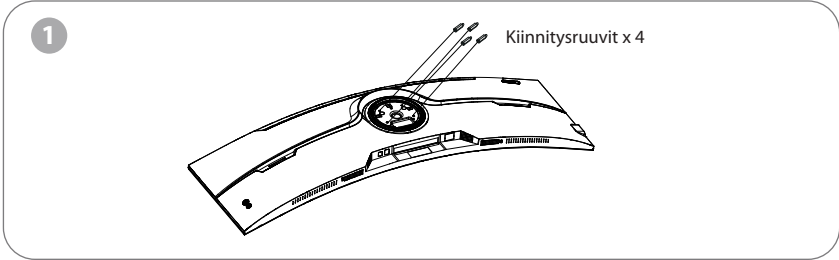

Asennuksen aikana älä purista näyttöä vahingoittumisen välttämiseksi. Katso seinätelineen (ostettava erikseen) asennusohjeet käyttöoppaasta.

Vihje: Tämän tuotteen kiinnitysaukkojen etäisyys on 75x75 mm.

⚠ Huom: Estääksesi näytön putoamisen, asenna se tukevasti ja varmista täysi suojaus. Älä sijoita tai ripusta esineitä telineeseen, ja telineen korkeus ei saa ylittää 2 metriä.

Näytön säätäminen

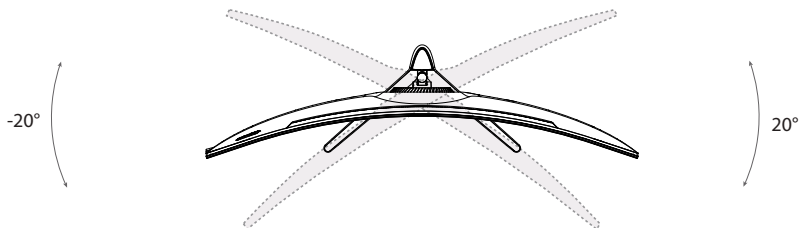

Kiertokulma

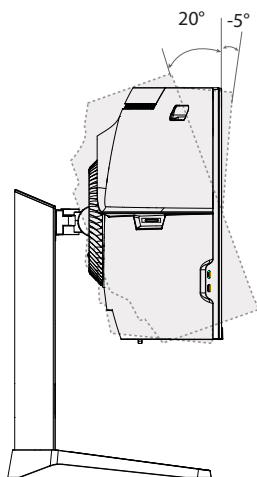
 $-20^{\circ}, +20^{\circ}$ 

Kallistuskulma

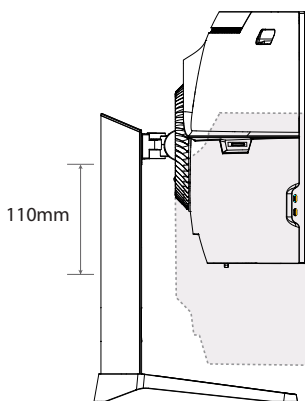
 $-5^{\circ}, +20^{\circ}$ 





Korkeusalue

110mm

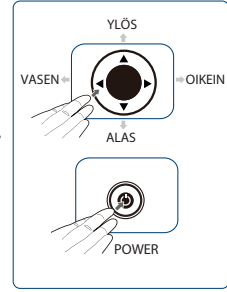
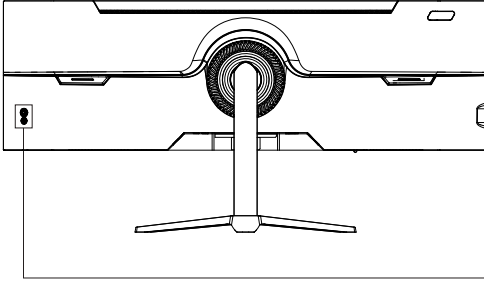
Käyttö

Painikkeiden kuvaus



Monitor Button	Action
 POWER	Napsauta virtapainiketta käynnistääksesi näytön.
 YLOS	Mahdollistaa äänenvoimakkuuden säätämisen.
 ALAS	Cross Aiming pikan äppäin (Pelauksen aikana).
 VASEN	Mahdollistaa signaalilähteen valinnan tai poistua OSD -valikosta.
 OIKEIN	Paina OSD -valikko.

Merkkivalojen selitys

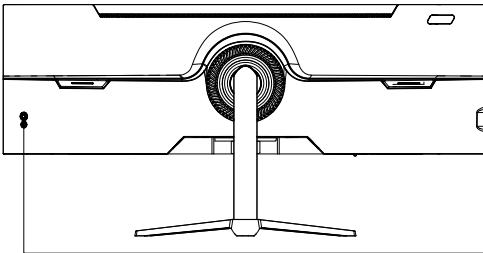

Merkkivalo

Merkkivalo: Tasainen sininen valo osoittaa, että virta on kytketty ja näyttö toimii normaalisti. Varmista, että tietokone on päällä ja että kaikki videokaapelit on kytketty ja/tai liitetty

OSD-valikko

Valikon kuvaus

- Varsinaisen näytön OSD-valikon väri ja muoto voivat poiketa hieman kuvassa esitetyistä.
- OSD-valikon tekniset tiedot voivat muuttua toimintojen parannusten myötä ilman ennakoilmoitusta.

Näytön näyttövalikkoa (OSD-valikko) voidaan käyttää monitorin asetusten säätämiseen, ja se tulee näyttöön, kun monitori on kytketty päälle ja ►painiketta painetaan.

1. Paina ►siirtyäksesi OSD-näyttöön.

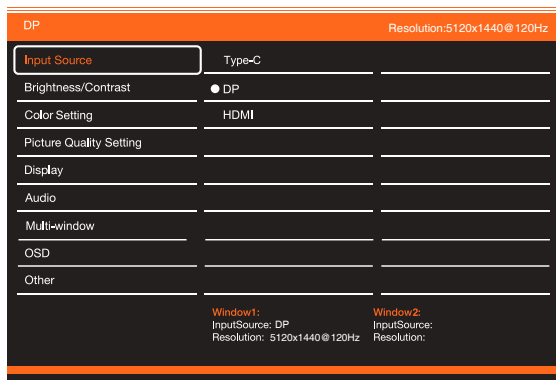

2. Selaa toimintoja painamalla ▼ tai ▲.

- Valitse haluamasi toiminto ja siirry sitten alivalikkoon painamalla ►painiketta.
- Selaa alivalikoita painamalla ▼ tai ▲ ja vahvista sitten haluamasi toiminnon valinta painamalla ►näppäintä.
- Valitse vaihtoehto painamalla tai ja vahvista sitten asetukset painamalla ► ja poistu nykyisestä valikosta.

3. Poistu valikkokäyttöliittymästä painamalla ►.

Tekniset tiedot

Tuotteen malli		C49ATILIUS2
Näyttöröudun koko		49" (124cm)
Kuvasuhte		32:9
Katselukulma		178°(H) / 178°(V)
Pikseliväli		0.2328 (H) × 0.2328 (V) mm
Kontrastisuhte		3000:1 (TYP)
Värit		16.7M (8 bit)
Resoluutio		5120x1440
Suurin virkistystaajuus		120Hz
Tehotyyppe		DC24V, 5A
Portit		HDMI+DP+USB-C+USB-B+USB-Ax2+AudioOut(äänilähtö)
Tuotteen mitat Jalusta	Ilman jalustaa	1185.64 x 192.44 x 365,53 mm
	Jalustan kanssa	1185.64 x 295.21 x 566.08 mm
Kallistuskulma		Eteenpäin kallistus: 5°; Kallistus taaksepäin: 20°
Korkeusalue		110 mm
Kiertokulma		-20°, +20°,
Kaiutin		2x3W
Nettopaino		7.8KG
Bruttopaino		11.9KG
Ympäristöolosuhteet	Toiminto	Lämpötila: 0 - 40°C (32 - 104°F) Kosteus: 10 - 90 % RH (ei-kondensoituva)
	Säilytys	Lämpötila: -20 - 60° (-4°F ~ 140°F) Kosteus: 5 - 95 % RH (ei-kondensoituva)



Termit HDMI ja HDMI High-Definition Multimedia Interface sekä HDMI-logo ovat HDMI Licensing Administrator, Inc:n tavaramerkkejä tai rekisteröityjä tavaramerkkejä Yhdysvalloissa ja muissa maissa.



HDMI™
HIGH-DEFINITION MULTIMEDIA INTERFACE



- Hävitä kaikki pakkaukset, paperi, kartongit ja muovipussit paikallisten kierrätysmääräysten mukaisesti.
- Hävitä tuote käyttöiän päätyttyä erillään kotitalousjätteestäsi valtuutetussa kotitalouksien sähkö- ja elektroniikkalaiteromun kierrätyskeskuksessa.
- Lisätietoja saat paikallisilta viranomaisilta tai jälleenmyyjältä, josta ostit tuotteen.

PowerInternational AS,
PO Box 523, 1471 Lørenskog, Norway

Power Norjassa:
<https://www.power.no/kundeservice/>
T: 21 00 40 00

Expert Tanskassa:
<https://www.expert.dk/kundeservice/>
T: 70 70 17 07

Power Tanskassa:
<https://www.power.dk/kundeservice/>
T: 70 33 80 80

Punkt 1 Tanskassa:
<https://www.punkt1.dk/kundeservice/>
T: 70 70 17 07

Power Suomessa:
<https://www.power.fi/tuki/asiakaspalvelu/>
T: 0305 0305

Power Ruotsissa:
<https://www.power.se/kundservice/>
T: 08 517 66 000

Produktpresentation

Innehåll i förpackningen



Bildskärm



Stativ



Bas



Bruksanvisning

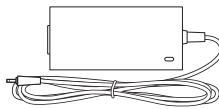

Strömadapter

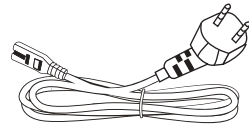

Power Cable

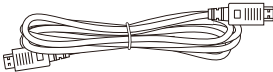

DP-kabel

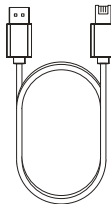

USB-A to B-kabel

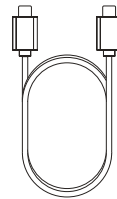

USB-C-kabel

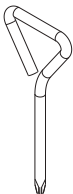

Skrummejsel

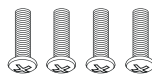

Skrudar x 4

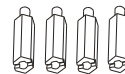

Monteringskrudar x 4

- Kvarvarande skruvar kan användas som reservskruvar.

Installation

Installation av basen

1

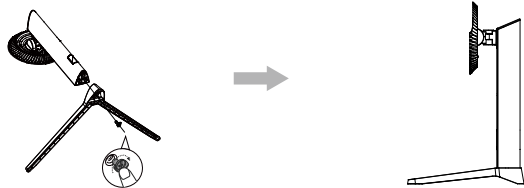

2

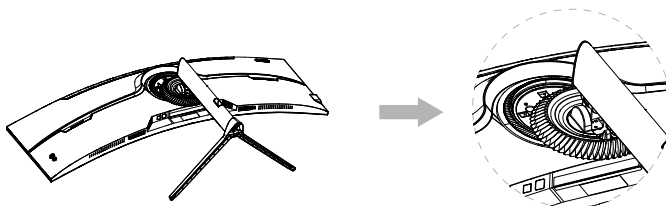

3

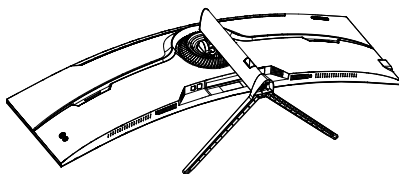

4

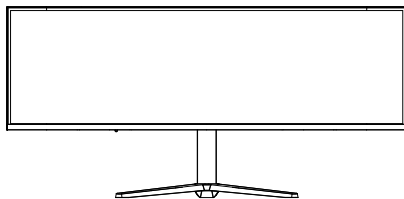

! Obs: Vid installation av skärmen, undvik att trycka på LCD-skärmen för att undvika skador.

Installation

Montering av fäste

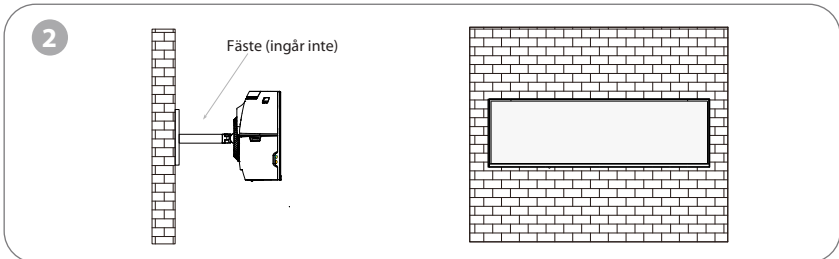
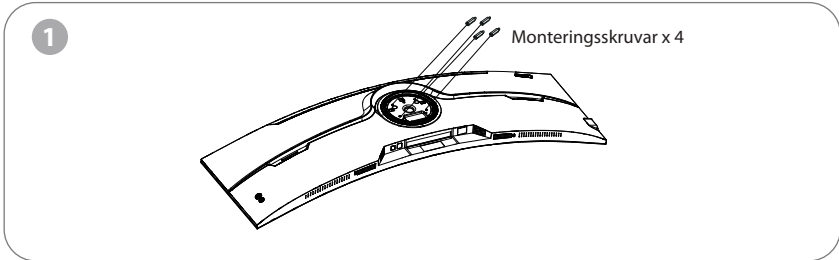

Under installationen, kläm inte skärmen för att undvika skador. Se användarmanualen för det separat inköpta väggfästet för installationsanvisningar.

Tips: Monteringshålsavståndet för denna produkt är 75x75 mm.

⚠ Obs: För att förhindra att skärmen faller, montera den säkert och säkerställ fullständigt skydd. Placera eller häng inte objekt på väggfästet, och väggfästets höjd bör vara mindre än 2 meter.

Justera bildskärmen

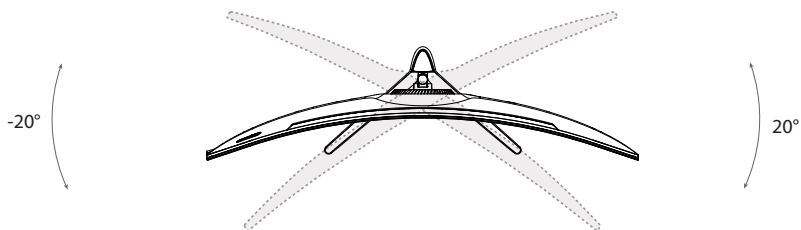

Rotationsvinkel

-20°, +20°

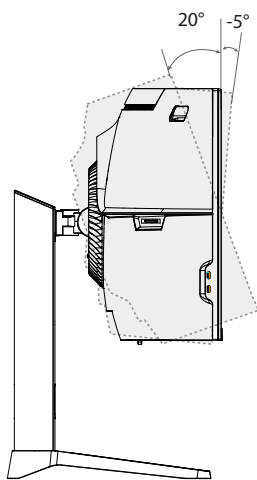

Lutningsvinkel

-5°, +20°

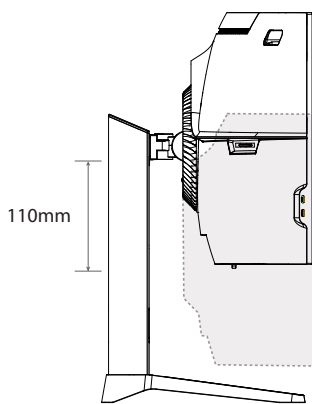





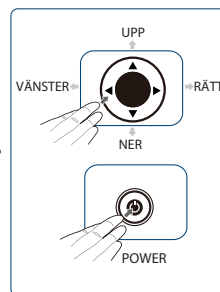
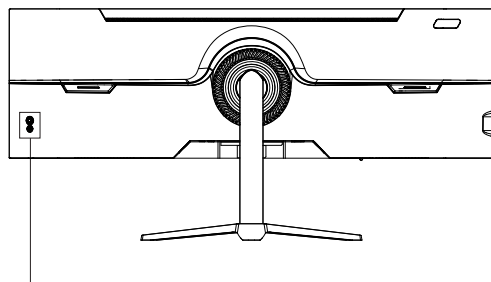

Höjdintervall

110mm

Användning

Beskrivning av knappar



Monitor Button	Action
 POWER	Klicka på strömknappen för att slå på monitorn.
 UPP	Möjliggör volymjustering.
 NER	Korsiktning genvägsknapp (Under spel).
 VÄNSTER	Tillåter val av signalkälla eller avsluta OSD -menyn.
 RÄTT	Tryck för att visa OSD -meny.

Förklaring av indikatorer

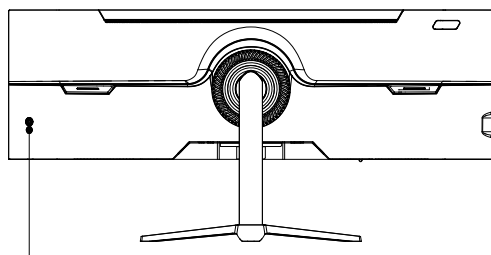

Indikator

Indikator: Ett stadigt blått ljus visar att strömmen är på och att skärmen fungerar normalt. Kontrollera att datorn är påslagen och att alla videokablar är helt anslutna.

OSD-menyn

Beskrivning av menyn

- Färgen och formen på OSD-menyn på den aktuella skärmen kan skilja sig något från dem som visas i figuren.
- Specifikationer för OSD-menyn kan ändras med förbättrade funktioner utan föregående meddelande.

OSD-menyn (On-screen display) kan användas för att justera skärmens inställningar och visas på skärmen efter att du har slagit på skärmen och trycker ► knappen.

1. Tryck ► för att öppna OSD-skärmen.

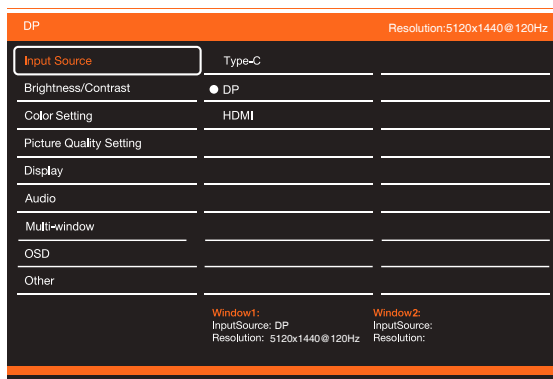

2. Tryck på ▼ eller ▲ för att bläddra bland funktionerna.
 - Välj önskad funktion och tryck sedan på ► knappen för att komma till undermenyn.
 - Tryck på ▼ eller ▲ för att bläddra i undermenyerna och tryck sedan på ► för att bekräfta valet av önskad funktion.
 - Tryck på ▼ eller ▲ för att välja ett alternativ och tryck sedan på ► för att bekräfta inställningen och lämna den aktuella menyn.
3. Tryck på ◀ för att lämna menygränssnittet.

Specifikationer

Produktmodell	C49ATILIUS2	
Skärmstorlek	49" (124cm)	
Bildförhållande	32:9	
Visningsvinkel	178°(H) / 178°(V)	
Pixelavstånd	0.2328 (H) × 0.2328 (V) mm	
Kontrastförhållande	3000:1(TYP)	
Färger	16.7M (8 bit)	
Upplösning	5120x1440	
Maximal uppdateringsfrekvens	120 Hz	
Strömtyper	DC24V,5A	
Portar	HDMI + DP + USB-C + USB-B + USB-Ax2 + Ljudutgång	
Produktmått Lyftbas	Utan bas	1185.64 x 192.44 x 365,53 mm
	Med bas	1185.64 x 295.21 x 566.08 mm
Lutningsvinkel	Framåtlutning: 5°; bakåtlutning: 20°	
Höjdintervall	110 mm	
Rotationsvinkel	-20°, +20°	
Högtalare	2x3W	
Nettovikt	7.8KG	
Bruttovikt	11.9KG	
Miljöförhållanden	Åtgärd	Temperatur: 0°C~ 40°C Luftfuktighet: 10%~90% RH (icke-kondenserande)
	Förvaring	Temperatur: -20°~ 60°C Luftfuktighet: 5%~95% RH (icke-kondenserande)



Termerna HDMI och HDMI High-Definition Multimedia Interface samt HDMI-logotypen är varumärken eller registrerade varumärken som tillhör HDMI Licensing Administrator, Inc. i USA och andra länder.



HDMITM
HIGH-DEFINITION MULTIMEDIA INTERFACE



- Kassera allt förpackningsmaterial, papper, kartonger och plastpåsar i enlighet med ditt lands lokala regler för återvinning.
- I slutet av produktens livslängd, kassera separat från hushållsavfallet på en godkänd WEEE-återvinningsstation.
- För ytterligare information, kontakta din kommun eller återförsäljare där du köpte produkten..

Power International AS,
PO Box 523, N-1471 Lørenskog, Norge

Power Norge:
<https://www.power.no/kundeservice/>
T: 21 00 40 00

Expert Danmark:
<https://www.expert.dk/kundeservice/>
T: 70 70 17 07

Power Danmark:
<https://www.power.dk/kundeservice/>
T: 70 33 80 80

Punkt 1 Danmark:
<https://www.punkt1.dk/kundeservice/>
T: 70 70 17 07

Power Finland:
<https://www.power.fi/tuki/asiakaspalvelu/>
T: 0305 0305

Power Sverige:
<https://www.power.se/kundeservice/>
T: 08 517 66 000

CEPTER