

**CEPTER**

**USER MANUAL**  
**49" Curved Monitor**

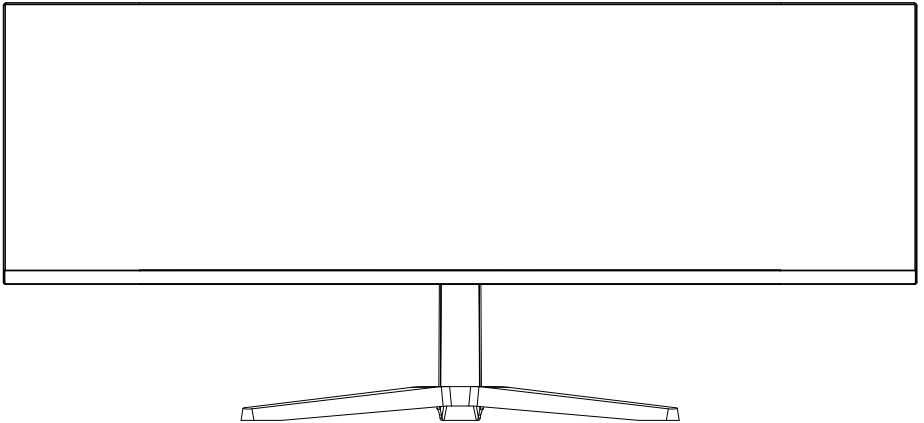

**C49ATILIUS3**

[www.ceptertech.com](http://www.ceptertech.com)



## **GB**

Thank you for choosing this Monitor.

Please read this instruction manual thoroughly before using and ensure you are familiar with the setup and operation of your new gaming gadget.

Retain this instruction manual for future reference.

## **NO**

Takk for at du valgte denne Monitoren.

Les denne bruksanvisningen nøye før bruk, og sørg for at du er kjent med oppsett og bruk av ditt nye spilltilbehør.

Ta vare på denne bruksanvisningen for fremtidig referanse.

## **DK**

Tak, for at dit valg af dette Skærm.

Læs venligst denne brugsanvisning grundigt inden brug, og sørg for, at du er bekendt med opsætningen og driften af din nye spille-enhed.

Behold denne brugsanvisning til senere brug.

## **FI**

Kiitos, kun valitsit tämän monitori.

Lue nämä käyttöohjeet perusteellisesti ennen käyttöä ja varmista, että olet tutustunut uuden pelilaitteesi asettamiseen ja käyttöön.

Säilytä tämä käyttöopas tulevaa tarvetta varten.

## **SE**

Tack för att du valt denna skärm.

Läs noggrant bruksanvisningen innan du använder spelenheten, för att se till att du har kunskap om dess inställningar och funktioner.

Spara bruksanvisningen för framtida referens.

Instruction Manual – English .....	page	3 - 10
Bruksanvisning – Norsk .....	side	11 - 18
Brugervejledning – Dansk .....	side	19 - 26
Käyttöopas - Suomi .....	sivu	27 - 34
Bruksanvisning – Svenska .....	sida	35 - 42

EN

NO

DK

FI

SE

**Product introduction****Packing list**

Monitor

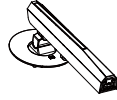

Stand

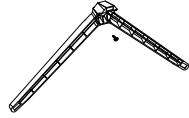

Base



User Manual

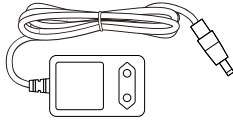

Power Adapter

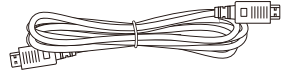

DP Cable

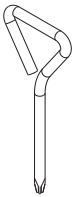

Screwdriver

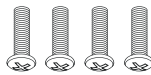

Screws x 4

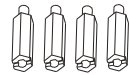

Mount Screws x 4

- Redundant screws can be used as spare screws.

**Installation****Installation of base**

1

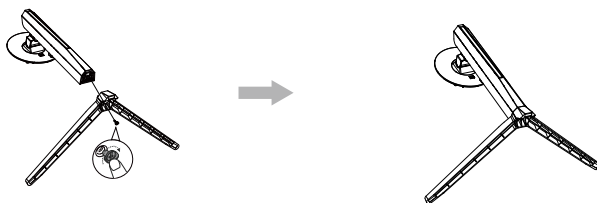

2

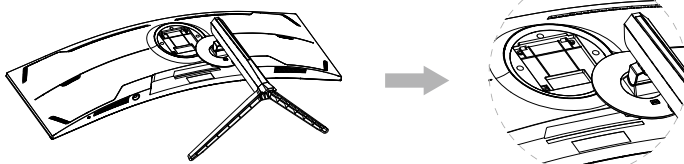

3

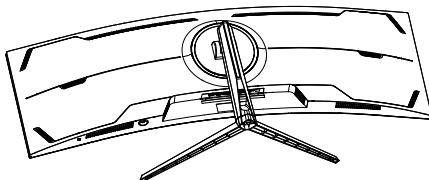

4

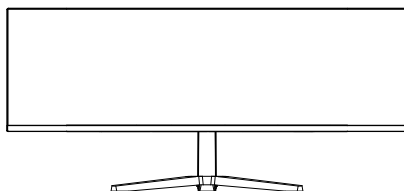

 **Note:** While setting up the monitor, do not press the liquid crystal screen to avoid damage.

## Installation

### Installation of mount

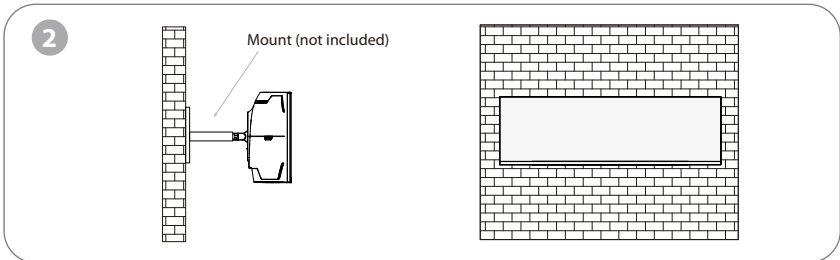
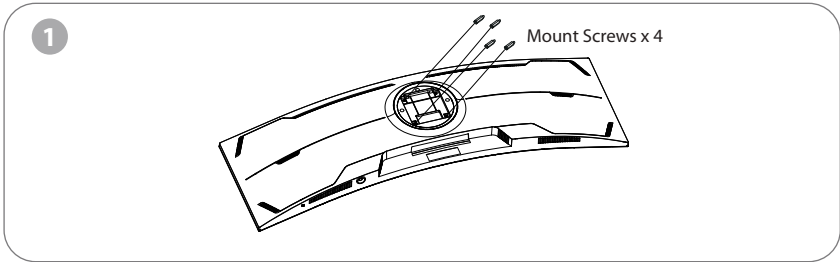

During installation, do not pinch the screen to avoid damage. Refer to the user manual of the separately purchased wall mount for installation instructions.

**Tip:** The mounting hole distance for this product is 100x100 mm.

**⚠ Note:** To prevent the monitor from falling, install it securely and ensure full protection. Do not place or hang objects on the wall mount, and the mount's height should be less than 2 meters.

## Adjusting the monitor

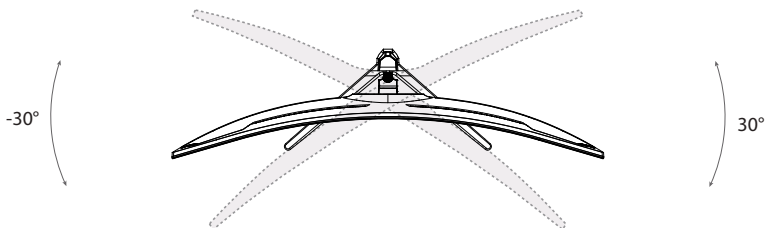

Rotation angle  
-30°, +30°

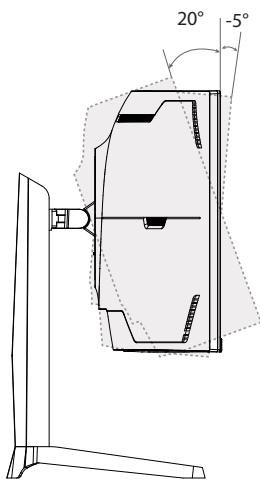

Tilting angle  
-5°, +20°

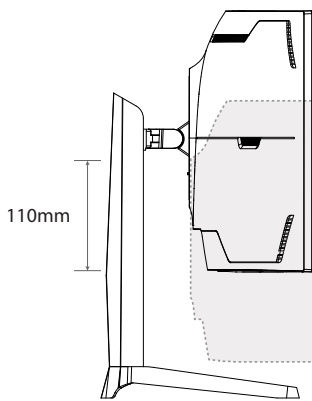



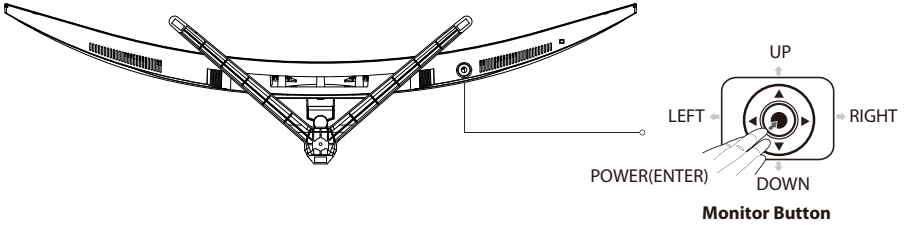

Height Adjustment  
110mm

## Usage

## Description of buttons



Monitor Button	Action
 POWER / ENTER	Click the Power button to turn on the monitor, then click to enter the options menu.
 UP	Allows for the selection of scenario patterns.
 DOWN	Cross Aiming Shortcut Button (During Gameplay).
 LEFT	Allows for the selection of signal source or exit the OSD menu.
 RIGHT	Allows for the brightness / contrast / DCR adjustment.

## Explanation of indicators

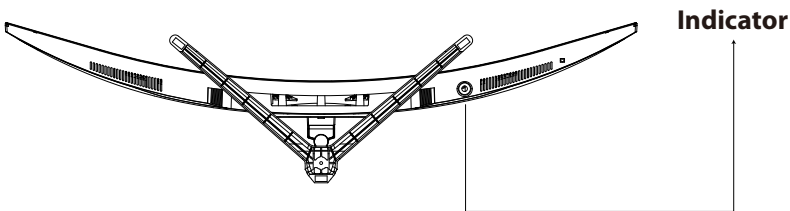

Indicator: Steady blue light indicates the power is on and the monitor runs normally. Please make sure that your computer is turned on and all video cables are fully plugged in and/or connected.

## OSD menu

- The color and shape of the OSD menu of the actual monitor may be slightly different from them shown in the figure.
  - Specifications of the OSD menu may change with improvements of functions without prior notice.
- The on-screen display (OSD) menu can be used to adjust the settings of the monitor and is displayed on the screen after turning on the monitor and pressing the ● button.

1. Press (●, ►) to enter the OSD screen.

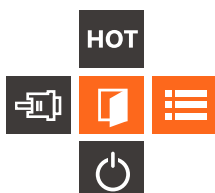

2. Press ▲ or ◀ to browse through the functions.

-Select the desired function, then press the ● button to enter the submenu.

-Press ▲ or ◀ to browse the sub-menus, and then press the ● key to confirm the selection of the desired function.

-Press ▲ or ◀ to select an option, then press ● to confirm the setting and exit the current menu.

## Specification

Product model		C49ATILIUS3
Screen Size		49" (124cm)
Aspect Ratio		32:9
Viewing Angle		178°(H) / 178°(V)
Pixel pitch		0.2328 (H) × 0.2328 (V) mm
Contrast ratio		3000:1(TYP)
Colors		16.7M (8 bit)
Resolution		5120x1440
Maximum refresh rate		165Hz
Power type		DC24V,3A
Ports		HDMI2.1x2 + DP1.4x2 + Audio Out
Product Dimensions	Without base	1188.9 x 178.12 x 366.55 mm
	Lifting base With base	1188.9 x 301.4 x 543.6 mm
Tilting angle		Forward tilting : 5°; Backward tilting: 20°
Height range		110mm
Rotation angle		-30°, +30°
Speaker		2x3W
Net Weight		8.0KG
Gross Weight		12.0KG
Environmental conditions	Action	Temperature: 0°C~ 40°C (32°F ~ 104°F) Humidity: 10%~90% RH (non-condensing)
	Storage	Temperature: -20°~ 60° (-4°F ~ 140°F) Humidity: 5%~95% RH (non-condensing)



The terms HDMI and HDMI High-Definition Multimedia Interface, and the HDMI Logo are trademarks or registered trademarks of HDMI Licensing Administrator, Inc. in the United States and other countries.



-Dispose of all packaging, paper, cartons and plastic bags in accordance with your local recycling regulations.

-At the end of the product's lifespan, please dispose of it separately from your household waste at an authorized household WEEE waste recycling centre.

-For more information, please contact the local authority or the retailer where you purchased the product.

Power International AS,  
PO Box 523, 1471 Lørenskog, Norway

Power Norge:  
<https://www.power.no/kundeservice/>  
T: 21 00 40 00

Expert Danmark:  
<https://www.expert.dk/kundeservice/>  
T: 70 70 17 07

Power Danmark:  
<https://www.power.dk/kundeservice/>  
T: 70 33 80 80

Punkt 1 Danmark:  
<https://www.punkt1.dk/kundeservice/>  
T: 70 70 17 07

Power Finland:  
<https://www.power.fi/tuki/asiakaspalvelu/>  
T: 0305 0305

Power Sverige:  
<https://www.power.se/kundeservice/>  
T: 08 517 66 000

## Produktintroduksjon

### Pakkeliste

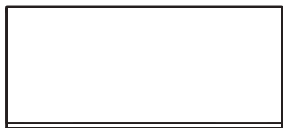

Skjerm

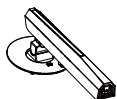

Gulvstativ

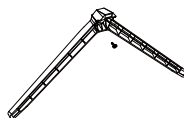

Sokkel



Bruksanvisning

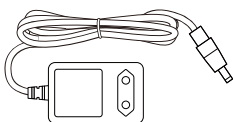

Strømadapter

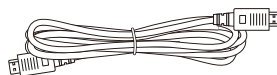

DP-kabel

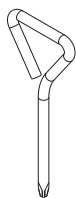

Skrutrekker

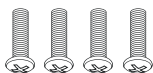

Skruer x 4

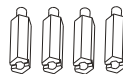

Festeskruer x 4

- Skruer som er til overs kan brukes som reserveskruer.

## Installasjon

## Montere sokkelen

1

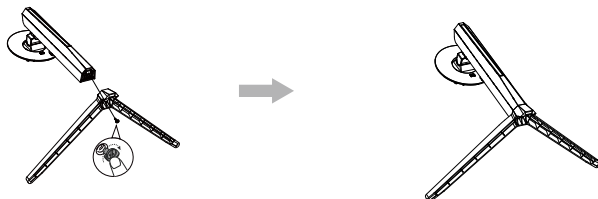

2

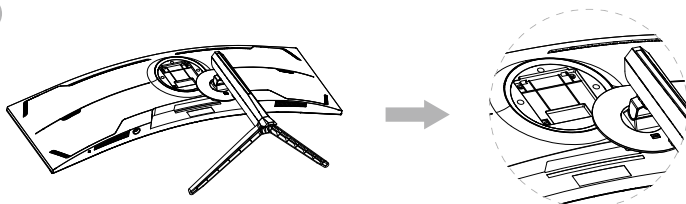

3

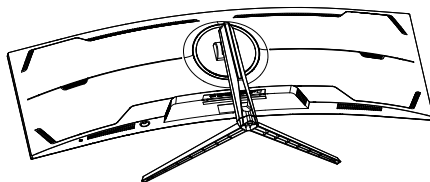

4

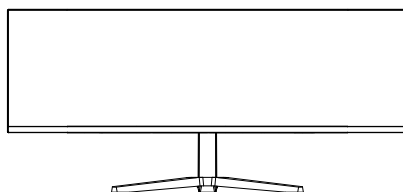

**⚠ Merk:** Når du setter opp skjermen, må du ikke trykke på LCD-skjermen for å unngå skade.

## Installasjon

### Montere feste

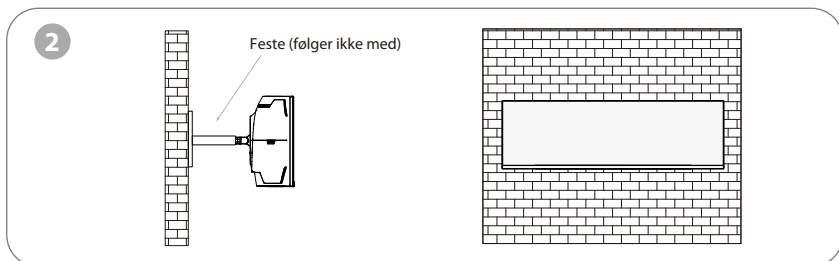
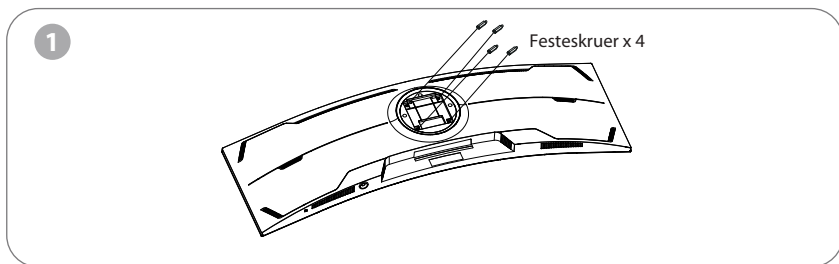

Under installasjonen, klem ikke skjermen for å unngå skade. Se i bruksanvisningen for den separat kjøpte veggfesten for installasjonsinstruksjoner.

**Tips:** Monteringshullavstanden for dette produktet er 100x100 mm.

**⚠ Merkt:** For å forhindre at skjermen faller, monter den sikkert og sørg for full beskyttelse. Ikke plasser eller heng objekter på festet, og festet skal være under 2 meter høyt.

## Justere skjermen

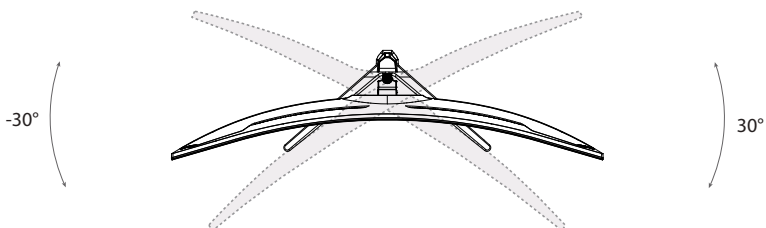

Drejevinkel

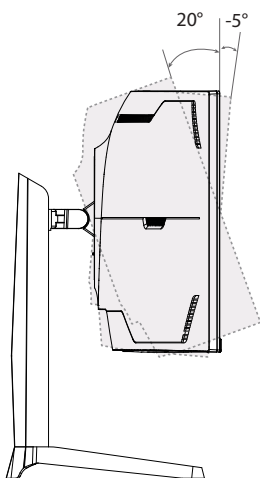
 $-30^{\circ}, +30^{\circ}$ 

Vippevinkel

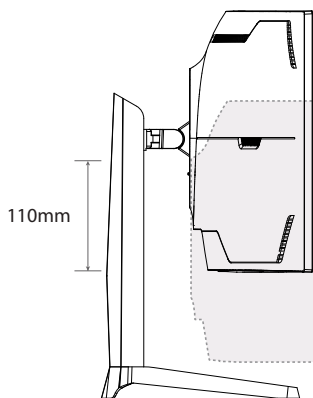
 $-5^{\circ}, +20^{\circ}$ 





Højde Område

110mm

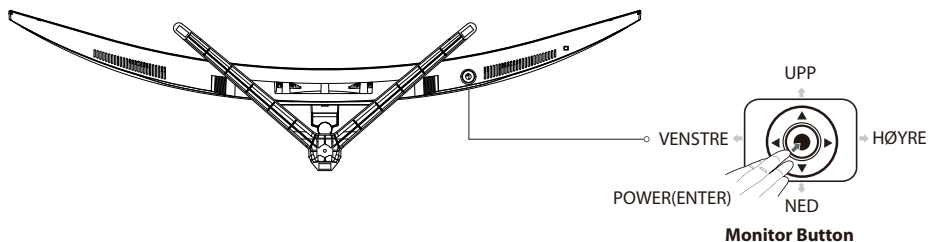
## Bruk

### Beskrivelse av knapper



Monitor Button	Action
 POWER / ENTER	Klikk på strømknappen for å slå på skjermen, og klikk deretter for å gå inn i alternativmenyen.
 UPP	Gir mulighet for valg av scenariomønstre.
 NED	Snarveisknapp for kryssikting (Under spilling).
 VENSTRE	Tillater valg av signalkilde eller avslutt OSD -menyen.
 HØYRE	Tillater justering av lysstyrken / kontrastforhold / DCR.

### Forklaring av indikatorer

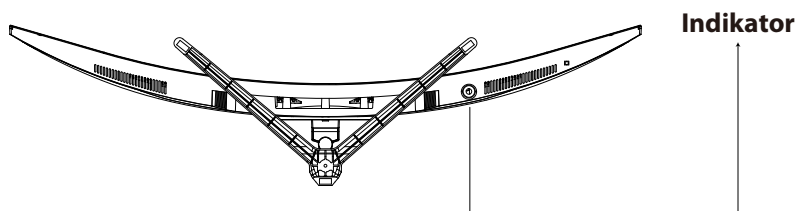

Indikator: Konstant blått lys indikerer at strømmen er på og skjermen kjører som normalt. Sørg for at datamaskinen er slått på og at alle videokabler er plugget inn og/eller tilkoblet.

## Skjermmeny

### Menybeskrivelse

- Fargen og formen på skjermmenyen til den faktiske skjermen kan være litt forskjellig fra det som vises på guren.
- Spesi kasjoner for skjermmenyen kan endres med forbedringer av funksjoner uten forvarsel.

På skjermmenyen kan man justere innstillingene på skjermen. Den vises på skjermen når man har slått på skjermen og trykket ● knappen.

1. Trykk (●, ►) for å gå inn i skjermmenyen.

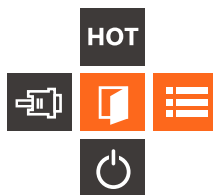

2. Trykk ◀ eller ▶ for å bla gjennom funksjonene.
- Velg ønsket funksjon, og trykk deretter ● knappen for å gå inn i undermenyen.
  - Trykk ◀ eller ▶ for å bla gjennom undermenyene, og trykk deretter ● knappen for å bekrefte valget av ønsket funksjon.
  - Trykk ◀ eller ▶ for å velge et alternativ, og trykk deretter ● for å bekrefte innstillingen og gå ut av gjeldende meny.

## Spesifikasjoner

Produktmodell		C49ATILIU53
Skjermstørrelse		49" (124cm)
Sideforhold		32:9
Betrakningsvinkel		178° (H) / 178° (V)
Pikselavstand		0.2328 (H) × 0.2328 (V) mm
Kontrastforhold		3000:1(TYP)
Farger		16.7M (8 bit)
Oppløsning		5120x1440
Maksimal oppdateringsfrekvens		165Hz
Strømtype		24V, 3A likestrøm
Porter		HDMI2.1x2 + DP1.4x2 + lyd ut
Produktets mål	Uten sokkel	1188.9 x 178.12 x 366.55 mm
	Løftesokkel	Med sokkel
Skråstillingsvinkel		Vipping forover: 5°; Vipping bakover: 20°
Høydeområde		110 mm
Rotasjonsvinkel		-30°, +30°
Høytaler		2x3W
Nettovekt		8.0KG
Bruttovekt		12.0KG
Miljøforhold	Handling	Temperatur: 0–40 °C (32–104 °F) Fuktighet: 10–90 % RF (ikke-kondenserende)
	Oppbevaring	Temperatur: -20–60 °C (-4–140 °F) Fuktighet: 5–95 % RF (ikke-kondenserende)



Begrepene HDMI og HDMI High-Definition Multimedia Interface, samt HDMI-logoen, er varemerker eller registrerte varemerker for HDMI Licensing Administrator, Inc., i USA og i andre land.



**HDMI**<sup>TM</sup>  
HIGH-DEFINITION MULTIMEDIA INTERFACE



- Kast all emballasje, papir, kartonger og plastposer i samsvar med lokale regler for resirkulering.
- Når produktet ikke skal brukes lenger, må det avhendes adskilt fra husholdningsavfall hos en miljøstasjon for gjenvinning av elektrisk og elektronisk avfall.
- Du får nærmere informasjon ved å kontakte lokale myndigheter eller forhandleren du kjøpte produktet hos.

Power International AS,  
Postboks Box 523, 1471 Lørenskog, Norge

Power Norge:  
<https://www.power.no/kundeservice/>  
T: 21 00 40 00

Expert Danmark:  
<https://www.expert.dk/kundeservice/>  
T: 70 70 17 07

Power Danmark:  
<https://www.power.dk/kundeservice/>  
T: 70 33 80 80

Punkt 1 Danmark:  
<https://www.punkt1.dk/kundeservice/>  
T: 70 70 17 07

Power Finland:  
<https://www.power.fi/tuki/asiakaspalvelu/>  
T: 0305 0305

Power Sverige:  
<https://www.power.se/kundservice/>  
T: 08 517 66 000

## Produktintroduktion

### Pakkens indhold



Skærm

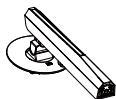

Fod

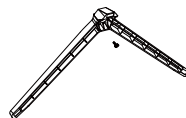

Fod



Brugervejledning

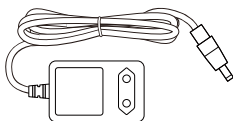

Strømadapter

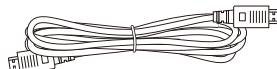

DP-kabel

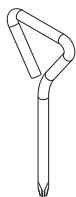

Skrutrækker

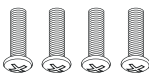

Skruer x 4

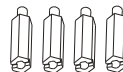

Skruer til vægmontering x 4

- Overskydende skruer kan bruges som reserveskruer.

## Opstilling

## Montering af foden

1

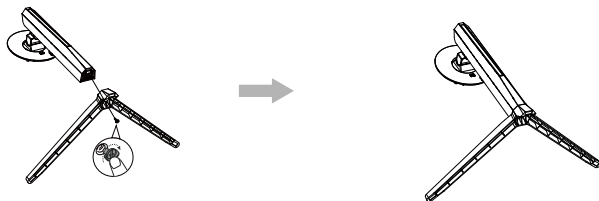

2

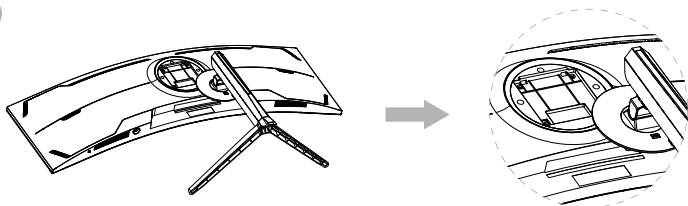

3

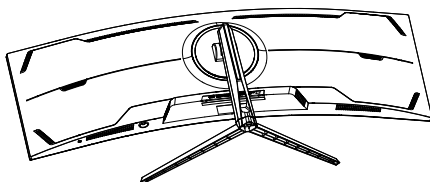

4

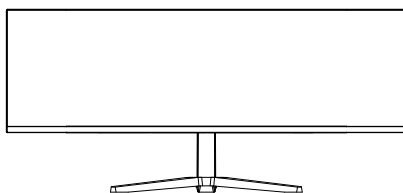

**!** Bemærk: Undgå at trykke på LCD-skærmen under opsætning for at undgå skader.

## Opstilling

## Montering af ophænget

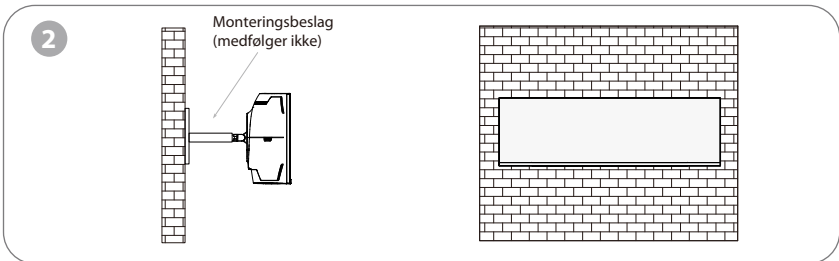
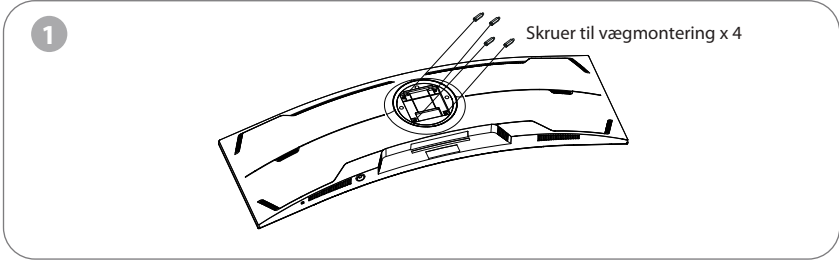

Under installationen må skærmen ikke klemmes for at undgå beskadigelse. Se brugermanualen for det separat købte vægbeslag for installationsinstruktioner.

**Tip:** Monteringshulafstanden for dette produkt er 100x100 mm.

**⚠ Bemærk:** For at forhindre, at skærmen falder, monter den sikkert og sørg for fuld beskyttelse. Placer eller hæng ikke genstande på vægbeslaget, og vægbeslagets højde bør være mindre end 2 meter.

## Justering af skærmen

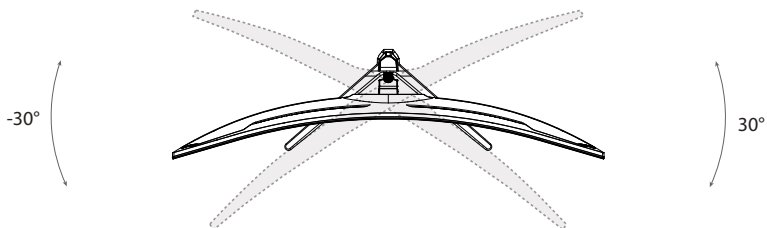

Drejevinkel  
-30°, +30°

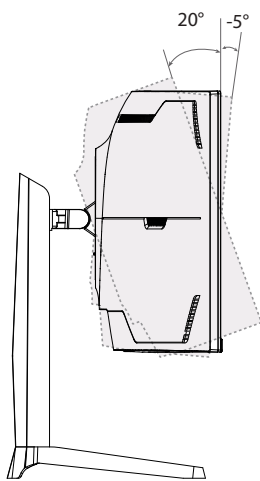

Vippevinkel  
-5°, +20°

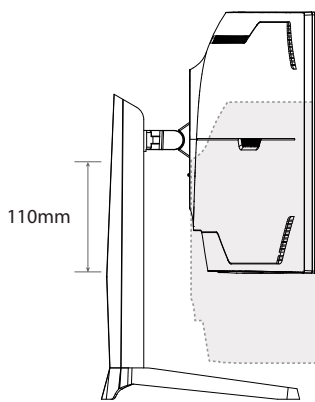



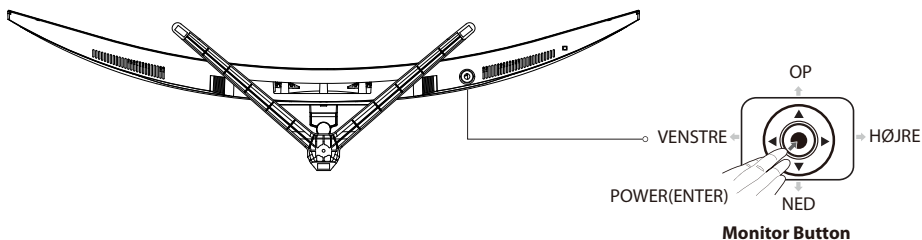

Højde Område  
110mm

## Brug

## Beskrivelse af knapperne



Monitor Button	Action
 POWER / ENTER	Klik på tænd/sluk-knappen for at tænde for skærmen, og klik derefter på for at åbne indstillingsmenuen.
 OP	Giver mulighed for valg af scenariemønstre.
 NED	Genvejsknap til krydsretning (Under gameplay).
 VENSTRE	Tillader valg af signalkilde eller udgang af OSD -menuen.
 HØJRE	Giver mulighed for justering af lysstyrken / kontrastforhold / DCR.

## Forklaring af indikatorerne

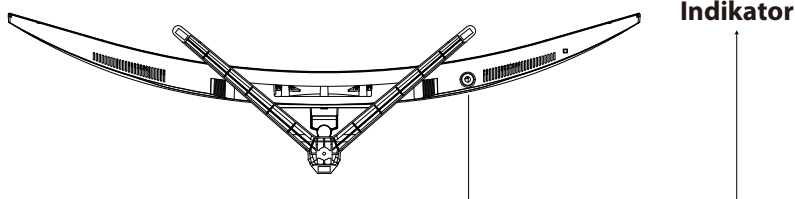

Lysindikator: Når indikatoren lyser blå betyder det, at strømmen er tændt, og at skærmen virker normalt. Sørg for, at din computer er tændt, og at alle videokabler er forbundet ordentligt.

## Skærmmenuen

### Menubeskrivelse

- Farven og formen på skærmmenuen på den faktiske skærm er muligvis ikke ens med skærmen på billedet.
- Særmmenuens funktioner ændres muligvis for, at forbedre dem. Dette kan ændres uden forudgående varsel.

I skærmmenuen (OSD) kan du justere skærmens indstillinger, hvilket vises på skærmen, når den tændes og der trykkes på ● knappen.

1. Tryk(●, ►) for at åbne skærmmenuen.

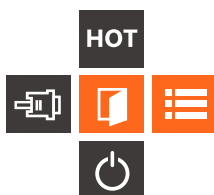

2. Brug ◀ and ▶ til, at skifte mellem punkterne.
  - Vælg det ønskede punkt, og tryk derefter på ● knappen for at åbne undermenuen.
  - Brug ◀ and ▶ til, at skifte mellem undermenuerne, og tryk derefter på ● knappen for, at bekræfte valget af det ønskede punkt.
  - Brug ◀ and ▶ til, at vælge et punkt, og tryk derefter på ● for at bekræfte indstillingen og lukke den aktuelle menu.

## Specifikationer

Produktmodel		C49ATILIUS3
Skærmstørrelse		49" (124cm)
Billedforhold		32:9
Synsvinkel		178° (H)/178° (V)
Pixelafstand		0.2328 (H) × 0.2328 (V) mm
Kontrastforhold		3000:1 (TYP)
Farver		16.7M (8 bit)
Opløsning		5120x1440
Maksimal opdateringshastighed		165Hz
Strømtype		Jævnstrøm 24V, 3A
Porte		HDMI2.1x2 + DP1.4x2 + Lydudgang
Produktmål Løftebund	Uden fod	1188.9 x 178.12 x 366.55 mm
	Med fod	1188.9 x 301.4 x 543.6 mm
Hældningsvinkel		Hældning fremad: 5°; Hældning bagud: 20°
Højde Område		110 mm
Drejevinkel		-30°, +30°
Højtaler		2 x 3W
Nettovægt		8.0KG
Bruttovægt		12.0KG
Miljøbetingelser	Handling	Temperature: 0°C~ 40°C (32°F ~ 104°F) Humidity: 10%~90% RH (non-condensing)
	Opbevaring	Temperatur: -20°~ 60° (-4°F ~ 140°F) Luftfugtighed: 5~ 95 % RH (ikke-kondenserende)



Udtrykkene HDMI og HDMI High-Definition Multimedia Interface og HDMI-logoet er varemærker eller registrerede varemærker tilhørende HDMI Licensing LLC i USA og andre lande.



- Bortskaf alt emballage, papir, kartoner og plastposer i overensstemmelse med dine lokale genbrugsbestemmelser.
- Ved slutningen af produktets levetid, skal det bortskafes separat fra dit husholdningsaffald på et godkendt genbrugsplads.
- Kontakt de lokale myndigheder eller forhandleren for yderligere oplysninger.

Power International AS,  
PO Box 523, 1471 Lørenskog, Norway

Power Norge:  
<https://www.power.no/kundeservice/>  
T: 21 00 40 00

Expert Danmark:  
<https://www.expert.dk/kundeservice/>  
T: 70 70 17 07

Power Danmark:  
<https://www.power.dk/kundeservice/>  
T: 70 33 80 80

Punkt 1 Danmark:  
<https://www.punkt1.dk/kundeservice/>  
T: 70 70 17 07

Power Finland:  
<https://www.power.fi/tuki/asiakaspalvelu/>  
T: 0305 0305

Power Sverige:  
<https://www.power.se/kundeservice/>  
T: 08 517 66 000

## Tuotteen esittely

### Pakkausluettelo



Monitori

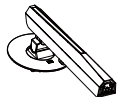

Jalusta

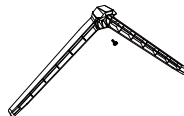

Pohjaosa



Käyttöopas

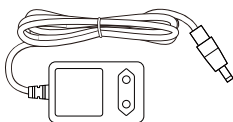

Virtasovitin

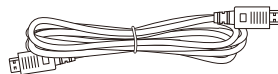

DP-kaapeli

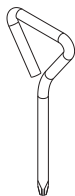

Ruuvitaltta

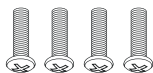

Ruuvit x 4

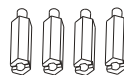

Kiinnitysruuvit x 4

- Ylimääräisiä ruuveja voidaan käyttää vararuuveina.

## Asennus

## Jalustan asennus

1

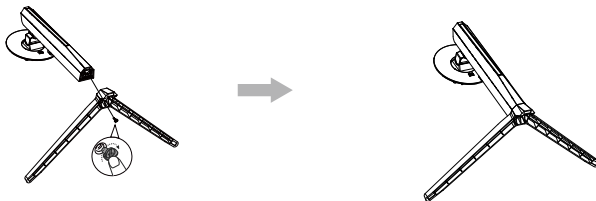

2

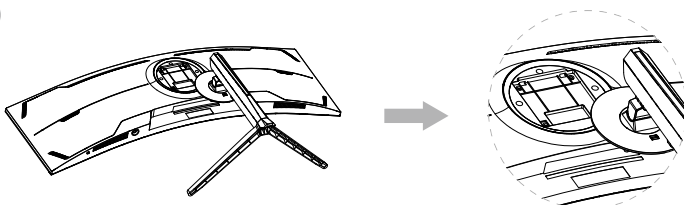

3

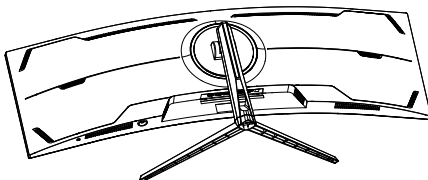

4

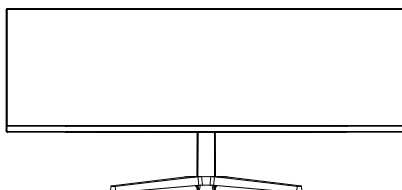

 **Huom:** Näyttöä asentaessa älä paina nestekidenäyttöä vaurioiden välttämiseksi.

## Asennus

## Seinätelineen asennus

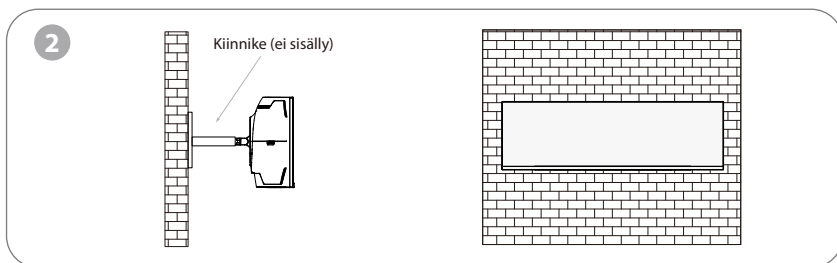
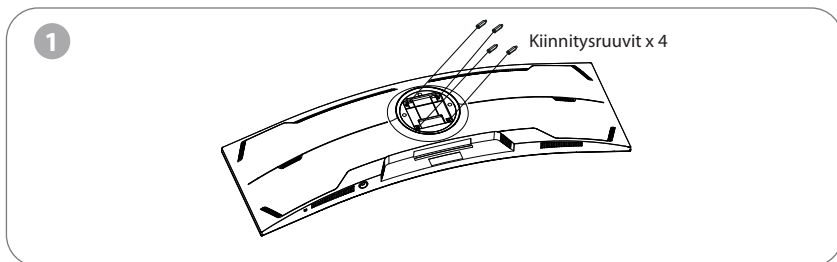

Asennuksen aikana älä purista näyttöä vahingoittumisen välttämiseksi. Katso seinätelineen (ostettava erikseen) asennusohjeet käyttöoppaasta.

**Vihje:** Tämän tuotteen kiinnitysaukkojen etäisyys on 100x100 mm.

**⚠ Huom:** Estääksesi näytön putoamisen, asenna se tukevasti ja varmista täysi suojaus. Älä sijoita tai ripusta esineitä telineeseen, ja telineen korkeus ei saa ylittää 2 metriä.

## Näytön säätäminen

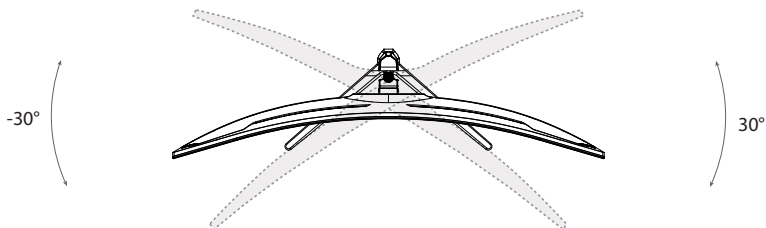

Kiertokulma  
-30°, +30°

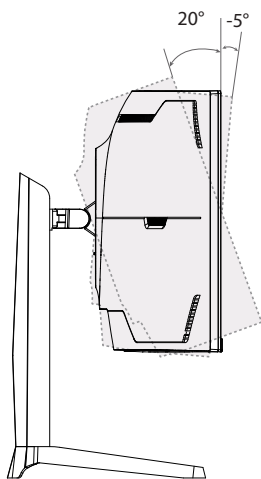

Kallistuskulma  
-5°, +20°

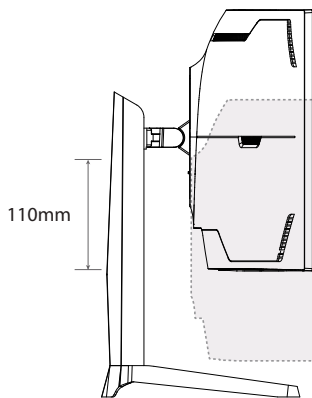



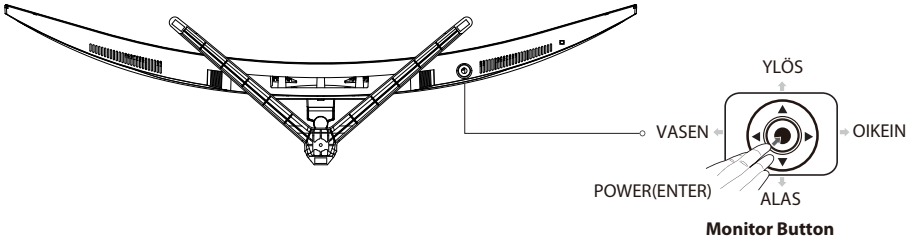

Korkeusalue  
110mm

## Käyttö

### Painikkeiden kuvaus



Monitor Button	Action
 POWER / ENTER	Napsauta virtapainiketta käynnistääksesi näytön ja napsauta sitten siirtyäksesi asetusvalikkoon.
 YLÖS	Mahdollistaa skenaariomallien valinnan.
 ALAS	Cross Aiming pikan äppäin (Pelauksen aikana).
 VASEN	Mahdollistaa signaalilähteen valinnan tai poistua OSD -valikosta.
 OIKEIN	Mahdollistaa kirkkauden säätämisen / kontrastisuhte / DCR.

### Merkkivalojen selitys

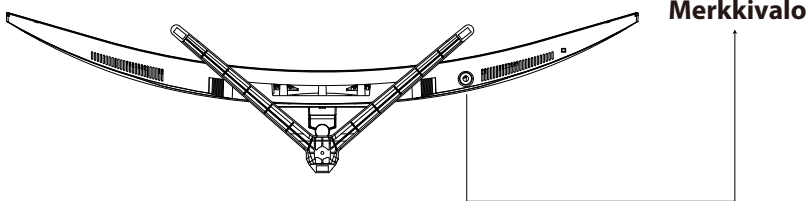

Merkkivalo: Tasainen sininen valo osoittaa, että virta on kytketty ja näyttö toimii normaalisti. Varmista, että tietokone on päällä ja että kaikki videokaapelit on kytketty ja/tai liitetty

## OSD-valikko

## Valikon kuvaus

- Varsinaisen näytön OSD-valikon väri ja muoto voivat poiketa hieman kuvassa esitetystä.
- OSD-valikon tekniset tiedot voivat muuttua toimintojen parannusten myötä ilman ennakoilmoitusta.

Näytön näyttövalikkoa (OSD-valikko) voidaan käyttää monitorin asetusten säätämiseen, ja se tulee näyttöön, kun monitori on kytketty päälle ja ● painiketta painetaan.

1. Paina (●, ▶) siirtyäksesi OSD-näyttöön.

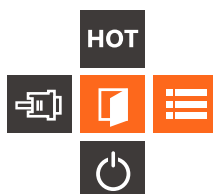

2. Selaa toimintoja painamalla ◀ tai ▶.

- Valitse haluamasi toiminto ja siirry sitten alivalikkoon painamalla ● painiketta.
- Selaa alivalikoita painamalla ◀ tai ▶ ja vahvista sitten haluamasi toiminnon valinta painamalla ● näppäintä.
- Valitse vaihtoehto painamalla ◀ tai ▶ ja vahvista sitten asetukset painamalla ● ja poistu nykyisestä valikosta.

## Tekniset tiedot

Tuotteen malli		C49ATILIUS3
Näyttöruudun koko		49" (124cm)
Kuvasuhte		32:9
Katselukulma		178°(H) / 178°(V)
Pikseliväli		0.2328 (H) × 0.2328 (V) mm
Kontrastisuhte		3000:1 (TYP)
Värit		16.7M (8 bit)
Resoluutio		5120x1440
Suurin virkistystaajuus		165Hz
Tehotyyppe		DC24V, 3A
Portit		HDMI2.1x2 + DP1.4x2 + AudioOut(äänilähtö)
Tuotteen mitat Jalusta	Ilman jalustaa	1188.9 x 178.12 x 366.55 mm
	Jalustan kanssa	1188.9 x 301.4 x 543.6 mm
Kallistuskulma		Eteenpäin kallistus: 5°; Kallistus taaksepäin: 20°
Korkeusalue		110 mm
Kiertokulma		-30°, +30°,
Kaiutin		2x3W
Nettopaino		8.0KG
Bruttopaino		12.0KG
Ympäristöolosuhteet	Toiminto	Lämpötila: 0 - 40°C (32 - 104°F) Kosteus: 10 - 90 % RH (ei-kondensoituva)
	Säilytys	Lämpötila: -20 - 60° (-4°F ~ 140°F) Kosteus: 5 - 95 % RH (ei-kondensoituva)



Termit HDMI ja HDMI High-Definition Multimedia Interface sekä HDMI-logo ovat HDMI Licensing Administrator, Inc:n tavaramerkkejä tai rekisteröityjä tavaramerkkejä Yhdysvalloissa ja muissa maissa.



- Hävitä kaikki pakkaukset, paperi, kartongit ja muovipussit paikallisten kierrätysmääräysten mukaisesti.
- Hävitä tuote käyttöiän päätyttyä erillään kotitalousjätteestäsi valtuutetussa kotitalouksien sähkö- ja elektroniikkalaiteromun kierrätyskeskuksessa.
- Lisätietoja saat paikallisilta viranomaisilta tai jälleenmyyjältä, josta ostit tuotteen.

PowerInternational AS,  
PO Box 523, 1471 Lørenskog, Norway

Power Norjassa:  
<https://www.power.no/kundeservice/>  
T: 21 00 40 00

Expert Tanskassa:  
<https://www.expert.dk/kundeservice/>  
T: 70 70 17 07

Power Tanskassa:  
<https://www.power.dk/kundeservice/>  
T: 70 33 80 80

Punkt 1 Tanskassa:  
<https://www.punkt1.dk/kundeservice/>  
T: 70 70 17 07

Power Suomessa:  
<https://www.power.fi/tuki/asiakaspalvelu/>  
T: 0305 0305

Power Ruotsissa:  
<https://www.power.se/kundservice/>  
T: 08 517 66 000

## Produktpresentation

### Innehåll i förpackningen



Bildskärm

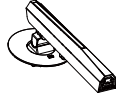

Stativ

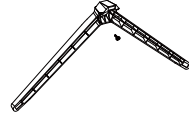

Bas



Bruksanvisning

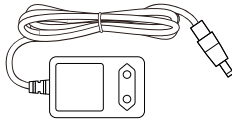

Strömadapter

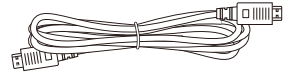

DP-kabel

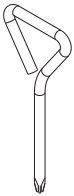

Skruvmejsel

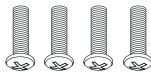

Skrudar x 4

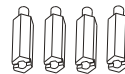

Monteringsskrudar x 4

- Kvarvarande skruvar kan användas som reservskruvar.

## Installation

## Installation av basen

1

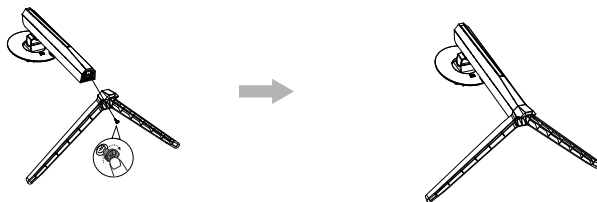

2

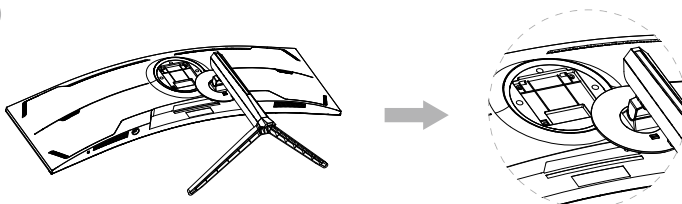

3

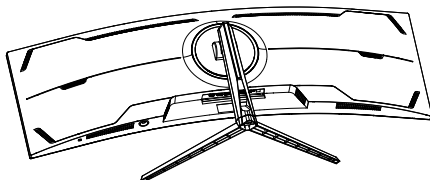

4

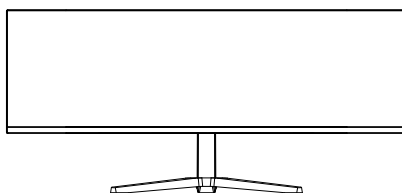

**!** Obs: Vid installation av skärmen, undvik att trycka på LCD-skärmen för att undvika skador.

## Installation

### Montering av fäste

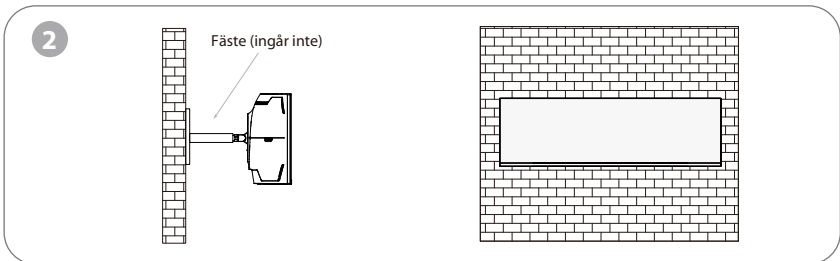
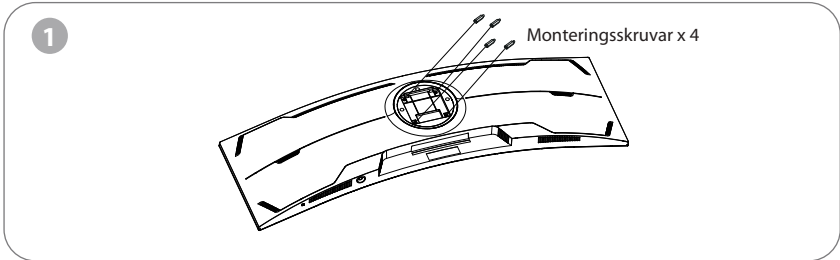

Under installationen, kläm inte skärmen för att undvika skador. Se användarmanualen för det separat inköpta väggfästet för installationsanvisningar.

**Tips:** Monteringshålsavståndet för denna produkt är 100x100 mm.

**⚠ Obs:** För att förhindra att skärmen faller, montera den säkert och säkerställ fullständigt skydd. Placera eller häng inte objekt på väggfästet, och väggfästets höjd bör vara mindre än 2 meter.

## Justera bildskärmen

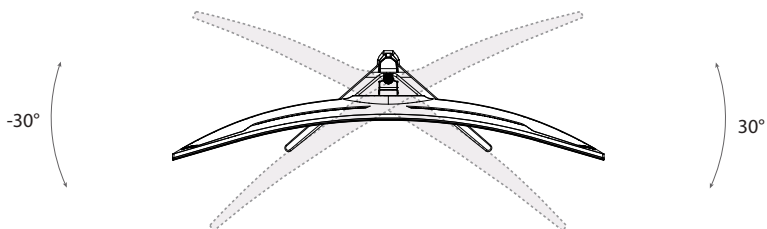

Rotationsvinkel

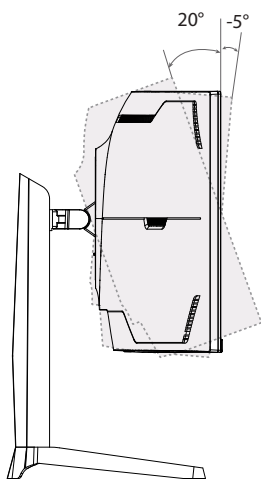
 $-30^{\circ}, +30^{\circ}$ 

Lutningsvinkel

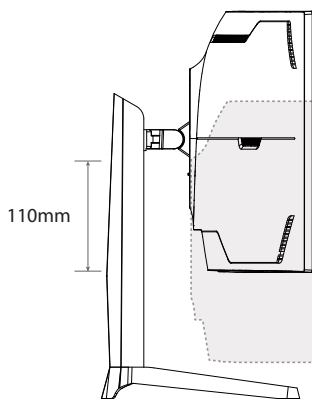
 $-5^{\circ}, +20^{\circ}$ 





Höjdintervall

110mm

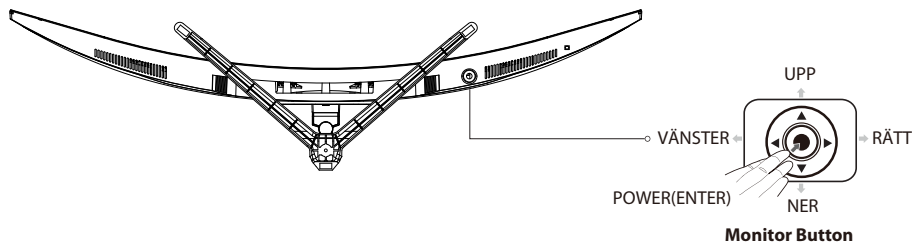
## Användning

### Beskrivning av knappar



Monitor Button	Action
 POWER / ENTER	Klicka på strömknappen för att slå på monitorn och klicka sedan för att öppna alternativmenyn.
 UPP	Möjliggör val av scenariomönster.
 NER	Korssiktning genvägsknapp (Under spel).
 VÄNSTER	Tillåter val av signalkälla eller avsluta OSD -menyn.
 RÄTT	Möjliggör justering av ljusstyrkan / kontrastförhållande / DCR.

### Förklaring av indikatorer

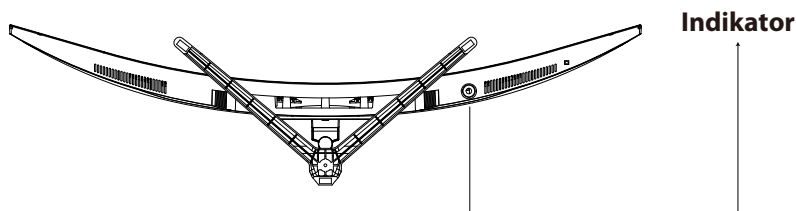

Indikator: Ett stadigt blått ljus visar att strömmen är på och att skärmen fungerar normalt. Kontrollera att datorn är påslagen och att alla videokablar är helt anslutna.

## OSD-menyn

### Beskrivning av menyn

- Färgen och formen på OSD-menyn på den aktuella skärmen kan skilja sig något från dem som visas i figuren.
- Specifikationer för OSD-menyn kan ändras med förbättrade funktioner utan föregående meddelande.

OSD-menyn (On-screen display) kan användas för att justera skärmens inställningar och visas på skärmen efter att du har slagit på skärmen och trycker ● knappen.

1. Tryck (●, ►) för att öppna OSD-skärmen.

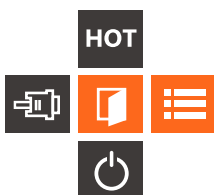

2. Tryck på ◀ eller ▶ för att bläddra bland funktionerna.
  - Välj önskad funktion och tryck sedan på ● knappen för att komma till undermenyn.
  - Tryck på ◀ eller ▶ för att bläddra i undermenyerna och tryck sedan på ● för att bekräfta valet av önskad funktion.
  - Tryck på ◀ eller ▶ för att välja ett alternativ och tryck sedan på ● för att bekräfta inställningen och lämna den aktuella menyn.

## Specifikationer

Produktmodell	C49ATILIUS3	
Skärmstorlek	49" (124cm)	
Bildförhållande	32:9	
Visningsvinkel	178°(H) / 178°(V)	
Pixelavstånd	0.2328 (H) × 0.2328 (V) mm	
Kontrastförhållande	3000:1(TYP)	
Färger	16.7M (8 bit)	
Upplösning	5120x1440	
Maximal uppdateringsfrekvens	165 Hz	
Strömtyper	DC24V,3A	
Portar	HDMI2.1x2 + DP1.4x2 + Ljudutgång	
Produktmått Lyftbas	Utan bas	1188.9 x 178.12 x 366.55 mm
	Med bas	1188.9 x 301.4 x 543.6 mm
Lutningsvinkel	Framåtlutning: 5°; bakåtlutning: 20°	
Höjdintervall	110 mm	
Rotationsvinkel	-30°, +30°	
Högtalare	2x3W	
Nettovikt	8.0KG	
Bruttovikt	12.0KG	
Miljöförhållanden	Åtgärd	Temperatur: 0°C~ 40°C Luftfuktighet: 10%~90% RH (icke-kondenserande)
	Förvaring	Temperatur: -20°~ 60°C Luftfuktighet: 5%~95% RH (icke-kondenserande)



Termerna HDMI och HDMI High-Definition Multimedia Interface samt HDMI-logotypen är varumärken eller registrerade varumärken som tillhör HDMI Licensing Administrator, Inc. i USA och andra länder.



**HDMI**™  
HIGH-DEFINITION MULTIMEDIA INTERFACE



- Kassera allt förpackningsmaterial, papper, kartonger och plastpåsar i enlighet med ditt lands lokala regler för återvinning.
- I slutet av produktens livslängd, kassera separat från hushållsavfallet på en godkänd WEEE-återvinningsstation.
- För ytterligare information, kontakta din kommun eller återförsäljare där du köpte produkten..

Power International AS,  
PO Box 523, N-1471 Lørenskog, Norge

Power Norge:  
<https://www.power.no/kundeservice/>  
T: 21 00 40 00

Expert Danmark:  
<https://www.expert.dk/kundeservice/>  
T: 70 70 17 07

Power Danmark:  
<https://www.power.dk/kundeservice/>  
T: 70 33 80 80

Punkt 1 Danmark:  
<https://www.punkt1.dk/kundeservice/>  
T: 70 70 17 07

Power Finland:  
<https://www.power.fi/tuki/asiakaspalvelu/>  
T: 0305 0305

Power Sverige:  
<https://www.power.se/kundeservice/>  
T: 08 517 66 000

**CEPTER**