

**CEPTER**

# **E-SPORT PRO GAMING OLED MONITOR**

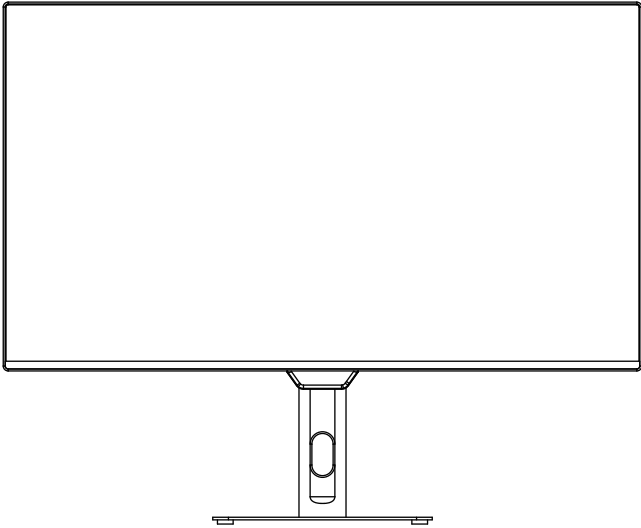

**USER MANUAL**

[www.ceptertech.com](http://www.ceptertech.com)



## **GB**

Thank you for choosing this Monitor.

Please read this instruction manual thoroughly before using and ensure you are familiar with the setup and operation of your new gaming gadget. Retain this instruction manual for future reference.

## **NO**

Takk for at du valgte denne Monitoren.

Les denne bruksanvisningen nøye før bruk, og sørg for at du er kjent med oppsett og bruk av ditt nye spilltilbehør.

Ta vare på denne bruksanvisningen for fremtidig referanse.

## **DK**

Tak, for at dit valg af dette Skærm.

Læs venligst denne brugsanvisning grundigt inden brug, og sørg for, at du er bekendt med opsætningen og driften af din nye spille-enhed.

Behold denne brugsanvisning til senere brug.

## **FI**

Kiitos, kun valitsit tämän monitori.

Lue nämä käyttöohjeet perusteellisesti ennen käyttöä ja varmista, että olet tutustunut uuden pelilaitteesi asettamiseen ja käyttöön.

Säilytä tämä käyttöopas tulevaa tarvetta varten.

## **SE**

Tack för att du valt denna skärm.

Läs noggrant bruksanvisningen innan du använder spelenheten, för att se till att du har kunskap om dess inställningar och funktioner.

Spara bruksanvisningen för framtida referens.

|                                    |      |         |
|------------------------------------|------|---------|
| Instruction Manual – English ..... | page | 3 - 10  |
| Bruksanvisning – Norsk .....       | side | 11 - 18 |
| Brugervejledning – Dansk .....     | side | 19 - 26 |
| Käyttöopas - Suomi .....           | sivu | 27 - 34 |
| Bruksanvisning – Svenska .....     | sida | 35 - 42 |

EN

NO

DK

FI

SE

## Product introduction

### Packing list

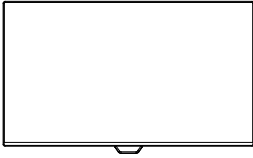

Monitor

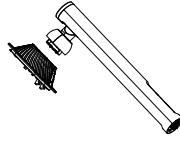

Stand

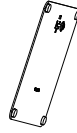

Base



User Manual

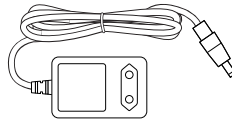

Power Adapter

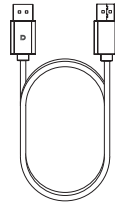

DP Cable

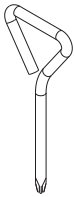

Screwdriver

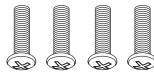



Screws x 4

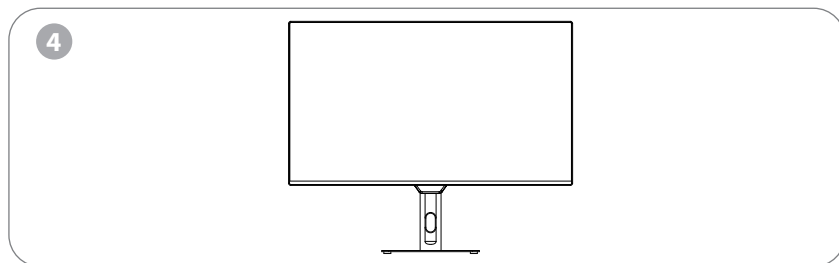
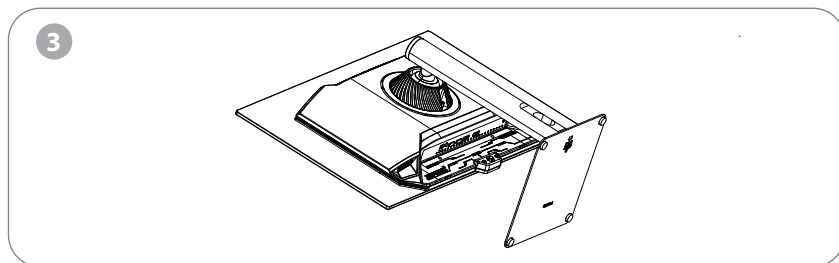
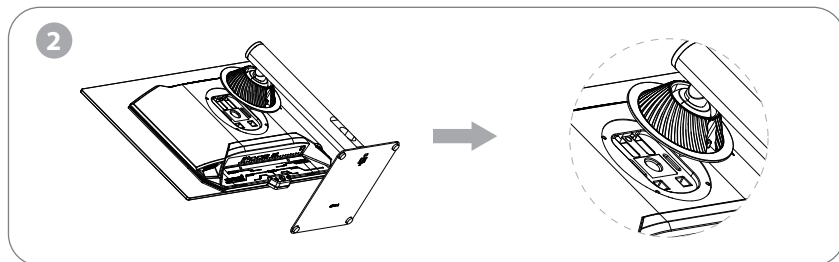
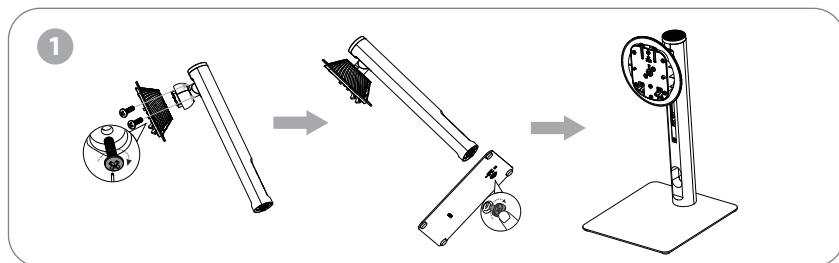

Screws x 2

- Redundant screws can be used as spare screws.

**Installation****Installation of base**

 **Note:** While setting up the monitor, do not press the liquid crystal screen to avoid damage.

## Installation

### Installation of mount

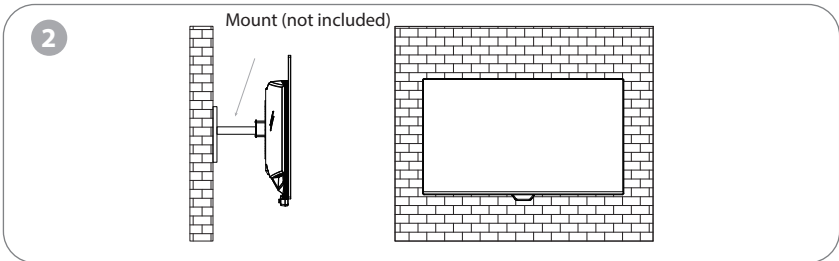
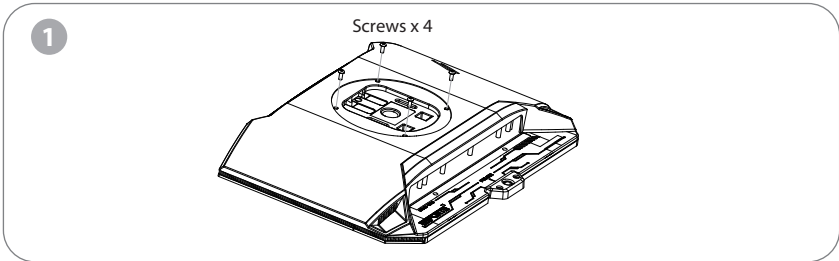

During installation, do not pinch the screen to avoid damage. Refer to the user manual of the separately purchased wall mount for installation instructions.

**Tip:** The mounting hole distance for this product is 100x100 mm.

**⚠ Note:** To prevent the monitor from falling, install it securely and ensure full protection. Do not place or hang objects on the wall mount, and the mount's height should be less than 2 meters.

## Adjusting the monitor

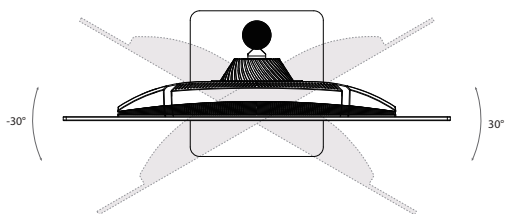

Rotation angle  
-30°, +30°

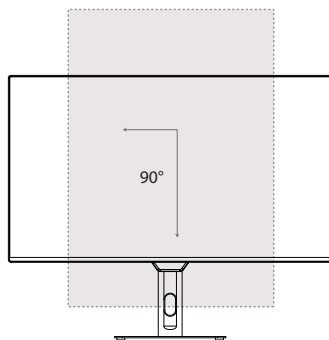

Rotation angle 90°

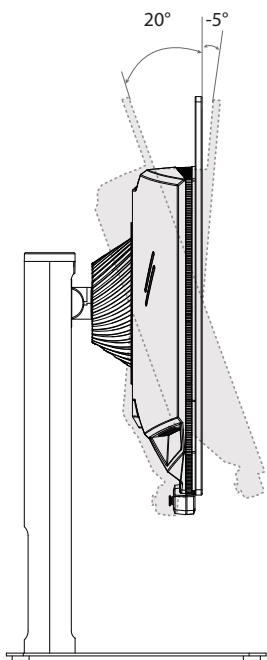

Tilting angle  
-5°, +20°

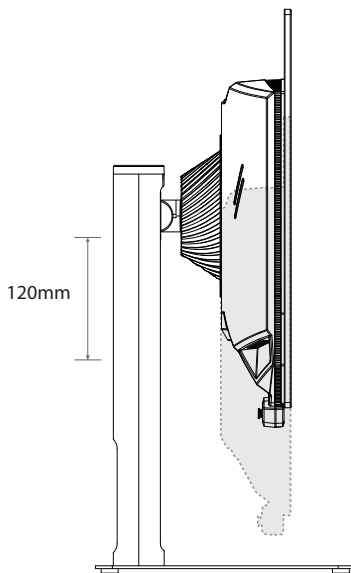





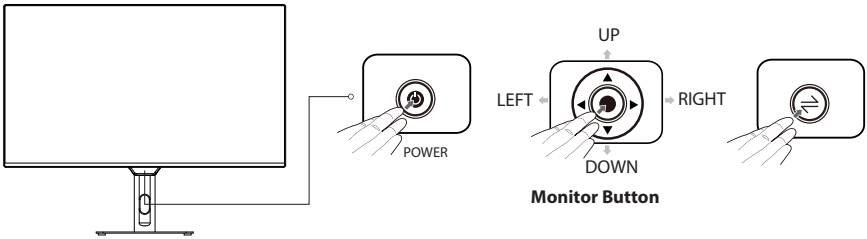

Height Adjustment  
120mm

## Usage

## Description of buttons



| Monitor Button   | Action  |
|--|---|
| <br>POWER | Click the Power button to turn on the monitor.                  |
| <br>UP    | Allows for the selection of scenario patterns.                  |
| <br>DOWN  | Allows for the volume adjustment.                               |
| <br>LEFT  | Allows for the selection of signal source or exit the OSD menu. |
| <br>RIGHT | Press to display OSD menu.                                      |
|           | Cross Aiming Shortcut Button (During Gameplay).                 |

## Explanation of indicators

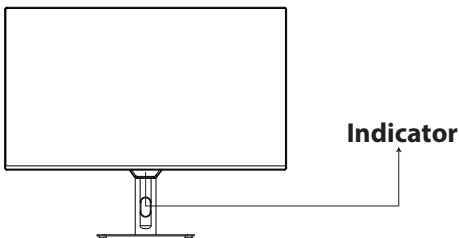

Indicator: Steady blue light indicates the power is on and the monitor runs normally. Please make sure that your computer is turned on and all video cables are fully plugged in and/or connected.

## OSD menu

## Menu description

- The color and shape of the OSD menu of the actual monitor may be slightly different from them shown in the figure.
  - Specifications of the OSD menu may change with improvements of functions without prior notice.
- The on-screen display (OSD) menu can be used to adjust the settings of the monitor and is displayed on the screen after turning on the monitor and pressing the ► button.

1. Press ► to enter the OSD screen.

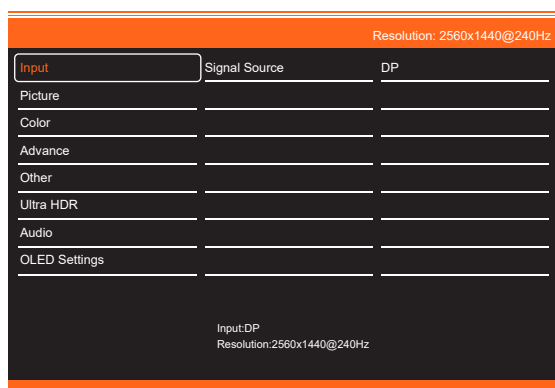

2. Press ▼ or ▲ to browse through the functions.

-Select the desired function, then press the ► button to enter the submenu.

-Press ▼ or ▲ to browse the sub-menus, and then press the ► key to confirm the selection of the desired function.

-Press ▼ or ▲ to select an option, then press ► to confirm the setting and exit the current menu.

3. Press ◀ to exit the menu interface.

## Specification

|                                    |              |  |
|------------------------------------|--------------|--|
| Product model                      |              | C27ESPORTP4  |
| Screen Size                        |              | 27" (68cm)   |
| Aspect Ratio                       |              | 16:9   |
| Viewing Angle                      |              | 178°(H) / 178°(V)  |
| Pixel pitch                        |              | 0.2292 (H) × 0.2292 (V) mm   |
| Contrast ratio                     |              | 1,500,000:1(TYP)   |
| Colors                             |              | 1.07B (10bit)  |
| Resolution                         |              | 2560x1440  |
| Maximum refresh rate               |              | 240Hz  |
| Power type                         |              | DC24V, 3A  |
| Ports                              |              | HDMI2.0x2 + DP1.4x1 + USB-Ax1(Firmware Update) + Audio Out                     |
| Product Dimensions<br>Lifting base | Without base | 610.9 x 61.8 x 353 mm  |
|                                    | With base    | 610.9 x 230 x 495.5 mm   |
| Tilting angle                      |              | Forward tilting : 5°; Backward tilting: 20°                                    |
| Height range                       |              | 120mm  |
| Rotation angle                     |              | -30°, +30°   |
| Speaker                            |              | 2x3W   |
| Net Weight                         |              | 4.6KG  |
| Gross Weight                       |              | 6.0KG  |
| Environmental conditions           | Action       | Temperature: 0°C~ 40°C (32°F ~ 104°F)<br>Humidity: 10%~90% RH (non-condensing) |
|                                    | Storage      | Temperature: -20°~ 60° (-4°F ~ 140°F)<br>Humidity: 5%~95% RH (non-condensing)  |



The terms HDMI and HDMI High-Definition Multimedia Interface, and the HDMI Logo are trademarks or registered trademarks of HDMI Licensing Administrator, Inc. in the United States and other countries.



-Dispose of all packaging, paper, cartons and plastic bags in accordance with your local recycling regulations.

-At the end of the product's lifespan, please dispose of it separately from your household waste at an authorized household WEEE waste recycling centre.

-For more information, please contact the local authority or the retailer where you purchased the product.

Power International AS,  
PO Box 523, 1471 Lørenskog, Norway

Power Norge:  
<https://www.power.no/kundeservice/>  
T: 21 00 40 00

Power Danmark:  
<https://www.power.dk/kundeservice/>  
T: 70 33 80 80

Punkt 1 Danmark:  
<https://www.punkt1.dk/kundeservice/>  
T: 70 70 17 07

Power Finland:  
<https://www.power.fi/tuki/asiakaspalvelu/>  
T: 0305 0305

Power Sverige:  
<https://www.power.se/kundeservice/>  
T: 08 517 66 000

## Produktintroduksjon

### Pakkeliste



Skjerm

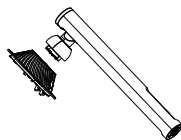

Gulvstativ

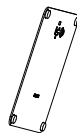

Sokkel



Bruksanvisning

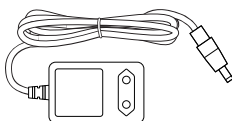

Strømadapter

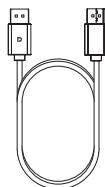

DP-kabel

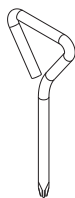

Skrutrekker

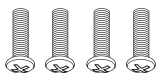

Skruer x 4



Skruer x 2

- Skruer som er til overs kan brukes som reserveskruer.

## Installasjon

## Montere sokkelen

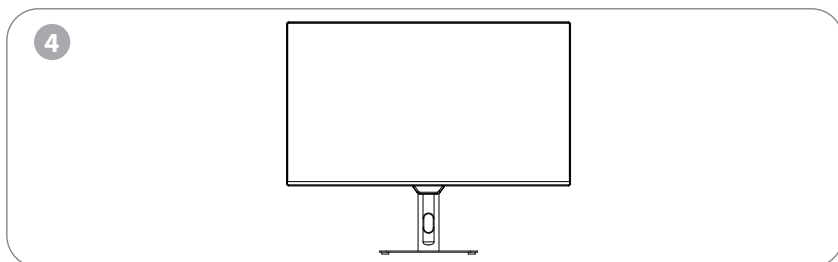
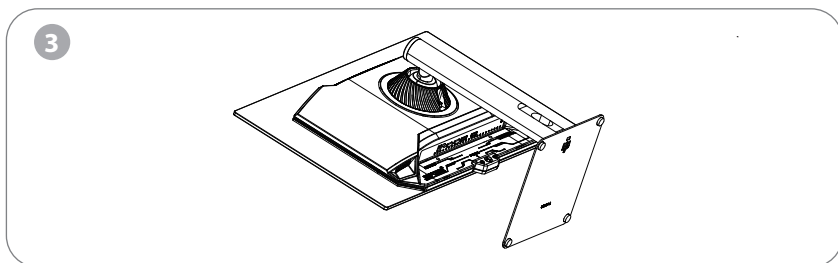
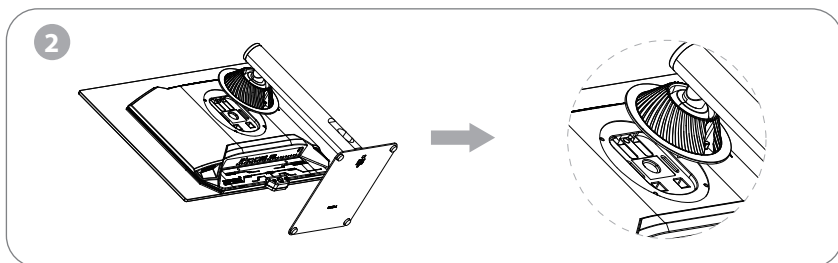
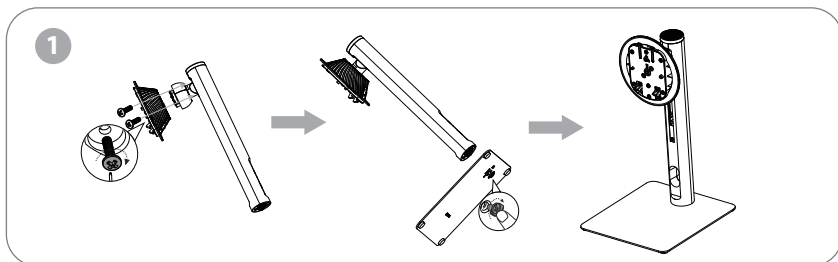

**!** **Merk:** Når du setter opp skjermen, må du ikke trykke på LCD-skjermen for å unngå skade.

## Installasjon

### Montere feste

1

Skruer x 4

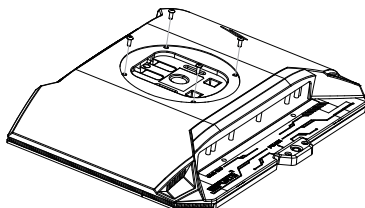

2

Feste (følger ikke med)

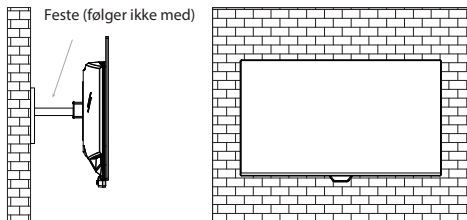

Under installasjonen, klem ikke skjermen for å unngå skade. Se i bruksanvisningen for den separat kjøpte veggfesten for installasjonsinstruksjoner.

**Tips:** Monteringshullavstanden for dette produktet er 100x100 mm.

**⚠ Merk:** For å forhindre at skjermen faller, monter den sikkert og sørg for full beskyttelse. Ikke plasser eller heng objekter på festet, og festet skal være under 2 meter høyt.

## Justere skjermen

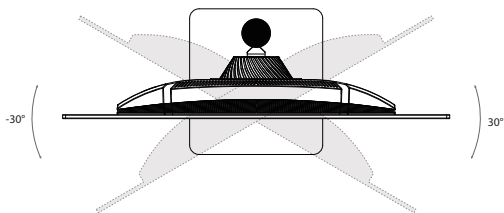

Rotasjonsvinkel  
-30°, +30°

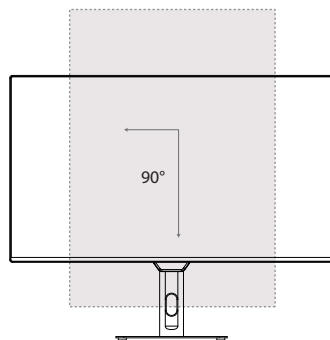

Rotasjonsvinkel 90°

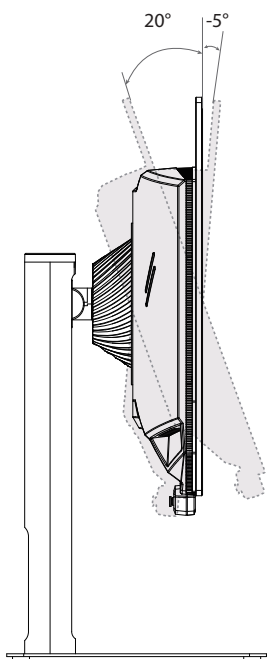

Skråstilling vinkel  
-5°, +20°

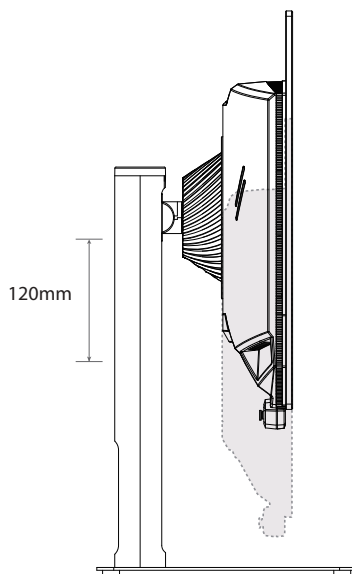





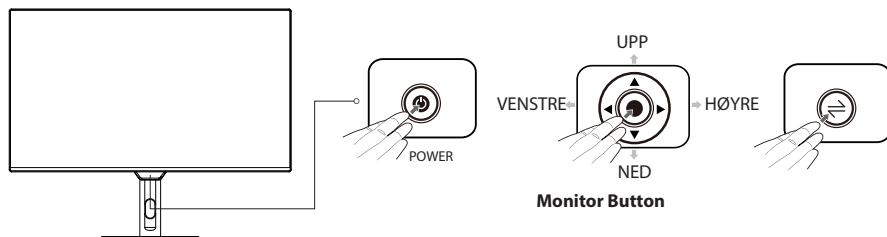

Høydeområde  
120mm

## Bruk

### Beskrivelse av knapper



| Monitor Button   | Action  |
|--|---|
| <br>POWER   | Klikk på strømknappen for å slå på skjermen.            |
| <br>UPP     | Gir mulighet for valg av scenariomønstre.               |
| <br>NED     | Tillater justering av lydnivå.                          |
| <br>VENSTRE | Tillater valg av signalkilde eller avslutt OSD -menyen. |
| <br>HØYRE   | Trykk for å vise OSD -meny.                             |
|             | Snarveisknapp for krysssikting (Under spilling).        |

### Forklaring av indikatorer

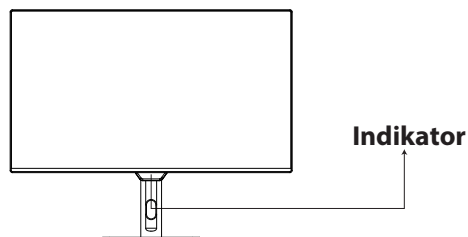

Indikator: Konstant blått lys indikerer at strømmen er på og skjermen kjører som normalt. Sørg for at datamaskinen er slått på og at alle videokabler er plugget inn og/eller tilkoblet.

## Skjermmeny

### Menybeskrivelse

- Fargen og formen på skjermmenyen til den faktiske skjermen kan være litt forskjellig fra det som vises på guren.
- Spesi kasjoner for skjermmenyen kan endres med forbedringer av funksjoner uten forvarsel.

På skjermmenyen kan man justere innstillingene på skjermen. Den vises på skjermen når man har slått på skjermen og trykket ► knappen.

1. Trykk ► for å gå inn i skjermmenyen.

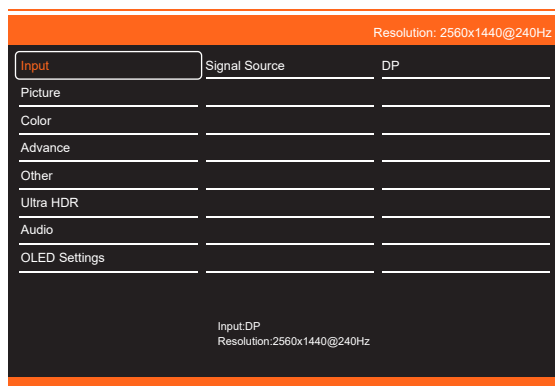

2. Trykk ▼ eller ▲ for å bla gjennom funksjonene.

- Velg ønsket funksjon, og trykk deretter ► knappen for å gå inn i undermenyen.
- Trykk ▼ eller ▲ for å bla gjennom undermenyene, og trykk deretter ► knappen for å bekrefte valget av ønsket funksjon.
- Trykk ▼ eller ▲ for å velge et alternativ, og trykk deretter ► for å bekrefte innstillingen og gå ut av gjeldende meny.

3. Trykk ◀ for å gå ut av menygrensesnittet.

## Spesifikasjoner

|                               |             |  |
|-------------------------------|-------------|--|
| Produktmodell                 |             | C27ESPORTP4  |
| Skjermstørrelse               |             | 27" (68cm)   |
| Sideforhold                   |             | 16:9   |
| Betraktningvinkel             |             | 178° (H) / 178° (V)  |
| Pikselavstand                 |             | 0.2292 (H) × 0.2292 (V) mm   |
| Kontrastforhold               |             | 1,500,000:1(TYP)   |
| Farger                        |             | 1.07B (10bit)  |
| Oppløsning                    |             | 2560x1440  |
| Maksimal oppdateringsfrekvens |             | 240Hz  |
| Strømtype                     |             | 24V, 3A likestrøm  |
| Porter                        |             | HDMI 2.0x2 + DP 1.4x1 + USB-Ax1 (fastvareoppdatering) + lyd ut                 |
| Produktets mål                | Uten sokkel | 610.9 x 61.8 x 353 mm  |
|                               | Med sokkel  | 610.9 x 230 x 495.5 mm   |
| Skråstillingsvinkel           |             | Vipping forover: 5°; Vipping bakover: 20°                                      |
| Høydeområde                   |             | 120 mm   |
| Rotasjonsvinkel               |             | -30°, +30°   |
| Høytaler                      |             | 2x3W   |
| Nettovekt                     |             | 4.6KG  |
| Bruttovekt                    |             | 6.0KG  |
| Miljøforhold                  | Handling    | Temperatur: 0–40 °C (32–104 °F)<br>Fuktighet: 10–90 % RF (ikke-kondenserende)  |
|                               | Oppbevaring | Temperatur: -20–60 °C (-4–140 °F)<br>Fuktighet: 5–95 % RF (ikke-kondenserende) |



Begrepene HDMI og HDMI High-Definition Multimedia Interface, samt HDMI-logoen, er varemerker eller registrerte varemerker for HDMI Licensing Administrator, Inc., i USA og i andre land.



- Kast all emballasje, papir, kartonger og plastposer i samsvar med lokale regler for resirkulering.
- Når produktet ikke skal brukes lenger, må det avhendes adskilt fra husholdningsavfall hos en miljøstasjon for gjenvinning av elektrisk og elektronisk avfall.
- Du får nærmere informasjon ved å kontakte lokale myndigheter eller forhandleren du kjøpte produktet hos.

Power International AS,  
Postboks Box 523, 1471 Lørenskog, Norge

Power Norge:  
<https://www.power.no/kundeservice/>  
T: 21 00 40 00

Power Danmark:  
<https://www.power.dk/kundeservice/>  
T: 70 33 80 80

Punkt 1 Danmark:  
<https://www.punkt1.dk/kundeservice/>  
T: 70 70 17 07

Power Finland:  
<https://www.power.fi/tuki/asiakaspalvelu/>  
T: 0305 0305

Power Sverige:  
<https://www.power.se/kundeservice/>  
T: 08 517 66 000

## Produktintroduktion

### Pakkens indhold



Skærm

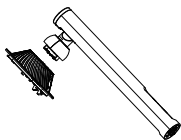

Fod

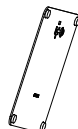

Fod



Brugervejledning

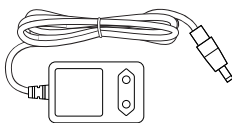

Strømadapter

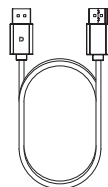

DP-kabel

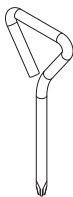

Skruetrækker

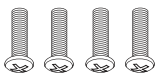

Skrue x 4



Skrue x 2

- Overskydende skruer kan bruges som reserveskruer.

## Opstilling

## Montering af foden

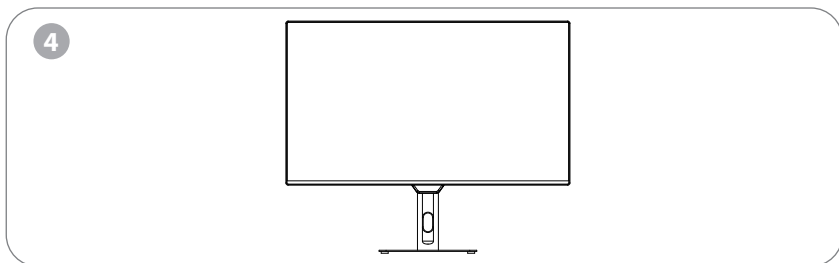
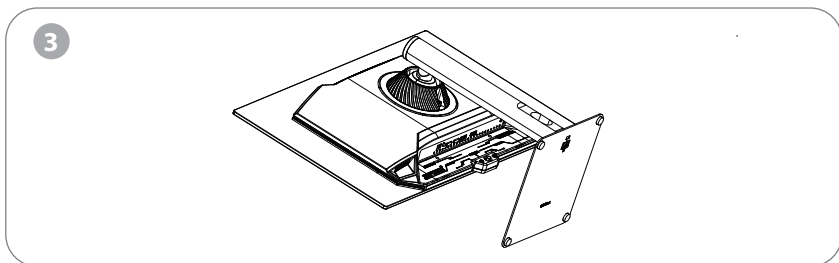
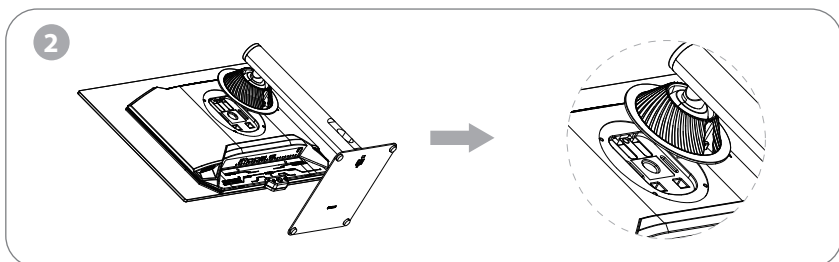
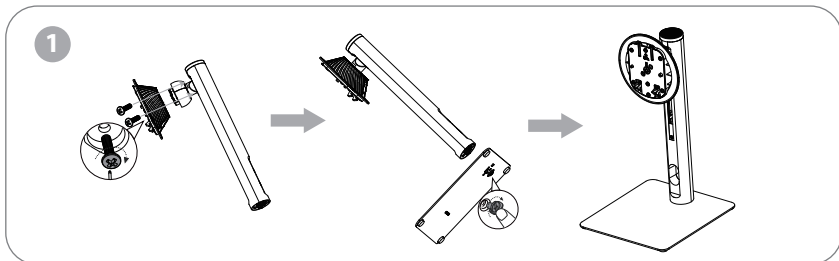

**⚠ Bemærk:** Undgå at trykke på LCD-skærmen under opsætning for at undgå skader.

## Opstilling

## Montering af ophænget

1

Skruer x 4

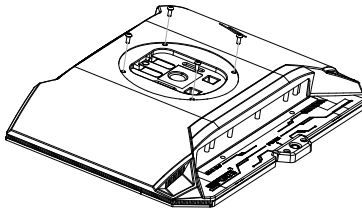

2

Monteringsbeslag (medfølger ikke)

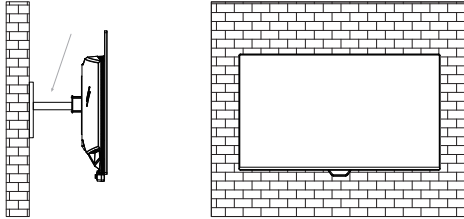

Under installationen må skærmen ikke klemmes for at undgå beskadigelse. Se brugermanualen for det separat købte vægbeslag for installationsinstruktioner.

**Tip:** Monteringshulafstanden for dette produkt er 100x100 mm.

**⚠ Bemærk:** For at forhindre, at skærmen falder, monter den sikkert og sørg for fuld beskyttelse. Placer eller hæng ikke genstande på vægbeslaget, og vægbeslagets højde bør være mindre end 2 meter.

## Justering af skærmen

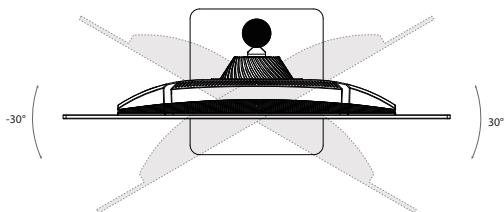

Drejevinkel  
-30°, +30°

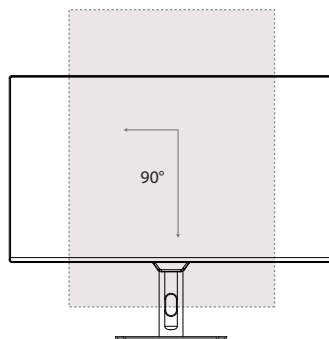

Drejevinkel 90°

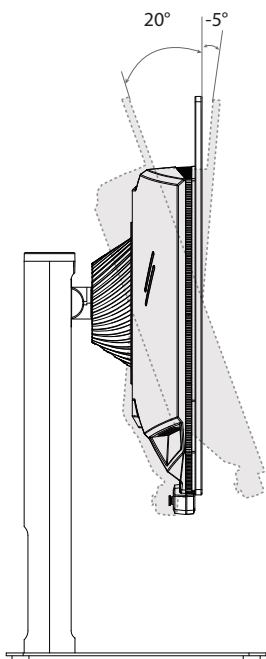

Vippevinkel  
-5°, +20°

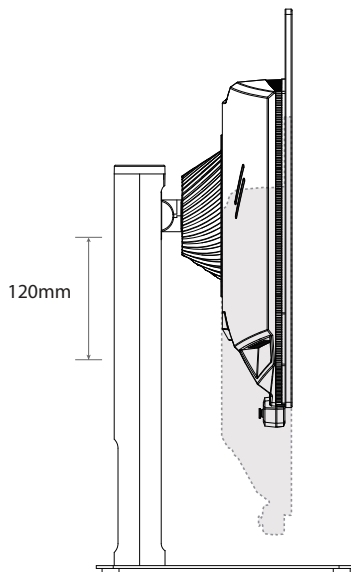





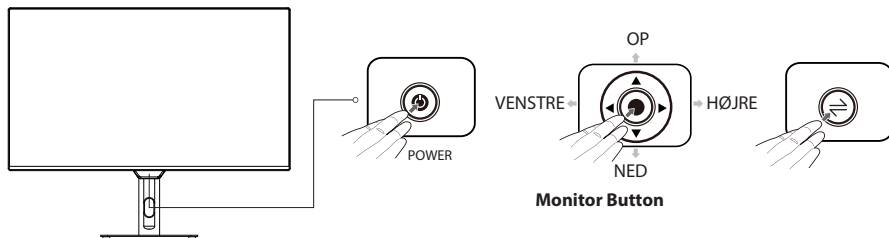

Højde Område  
120mm

## Brug

## Beskrivelse af knapperne



| Monitor Button   | Action  |
|--|---|
| <br>POWER   | Klik på tænd/sluk-knappen for at tænde for skærmen.       |
| <br>OP      | Giver mulighed for valg af scenariemønstre.               |
| <br>NED     | Muliggør justering af lydstyrken.                         |
| <br>VENSTRE | Tillader valg af signalkilde eller udgang af OSD -menuen. |
| <br>HØJRE   | Tryk på for at vise OSD -menu.                            |
|             | Genvejsknap til krydsretning (Under gameplay).            |

## Forklaring af indikatorerne

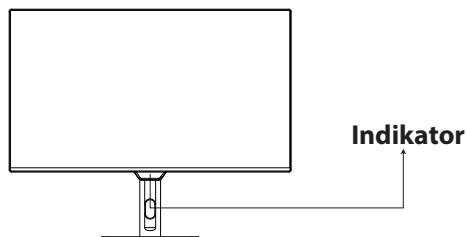

Lysindikator: Når indikatoren lyser blå betyder det, at strømmen er tændt, og at skærmen virker normalt. Sørg for, at din computer er tændt, og at alle videokabler er forbundet ordentligt.

## Skærmmenuen

### Menubeskrivelse

- Farven og formen på skærmmenuen på den faktiske skærm er muligvis ikke ens med skærmen på billedet.
- Særmmenuens funktioner ændres muligvis for, at forbedre dem. Dette kan ændres uden forudgående varsel.

I skærmmenuen (OSD) kan du justere skærmens indstillinger, hvilket vises på skærmen, når den tændes og der trykkes på ► knappen.

1. Tryk ► for at åbne skærmmenuen.

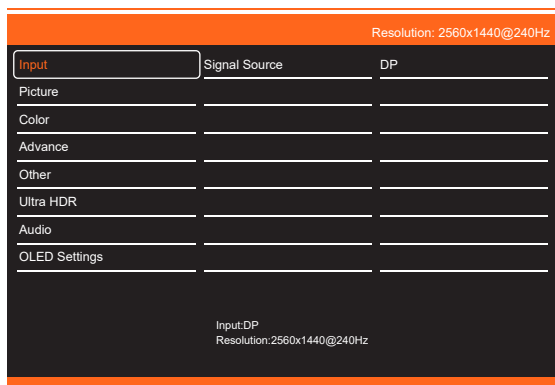

2. Brug ▼ og ▲ til, at skifte mellem punkterne.
  - Vælg det ønskede punkt, og tryk derefter på ► knappen for at åbne undermenuen.
  - Brug ▼ og ▲ til, at skifte mellem undermenuerne, og tryk derefter på ► knappen for, at bekræfte valget af det ønskede punkt.
  - Brug ▼ og ▲ til, at vælge et punkt, og tryk derefter på ► for at bekræfte indstillingen og lukke den aktuelle menu.
3. Tryk på ◀ for, at lukke menuen.

## Specifikationer

|                               |   |  |
|-------------------------------|---|--|
| Produktmodel                  | C27ESPORTP4   |  |
| Skærmstørrelse                | 27" (68cm)  |  |
| Billedforhold                 | 16:9  |  |
| Synsvinkel                    | 178° (H)/178° (V)   |  |
| Pixelafstand                  | 0.2292 (H) × 0.2292 (V) mm                                    |  |
| Kontrastforhold               | 1,500,000:1 (TYP)   |  |
| Farver                        | 1.07B (10bit)   |  |
| Opløsning                     | 2560x1440   |  |
| Maksimal opdateringshastighed | 240Hz   |  |
| Strømtype                     | Jævnstrøm 24V, 3A   |  |
| Porte                         | HDMI2.0x2 + DP1.4x1+ USB-Ax1 (Firmwareopdatering) + Lydudgang |  |
| Produktmål<br>Løftebund       | Uden fod  | 610.9 x 61.8 x 353 mm  |
|                               | Med fod   | 610.9 x 230 x 495.5 mm   |
| Hældningsvinkel               | Hældning fremad: 5°; Hældning bagud: 20°                      |  |
| Højde Område                  | 120 mm  |  |
| Drejevinkel                   | -30°, +30°  |  |
| Højtaler                      | 2 x 3W  |  |
| Nettovægt                     | 4.6KG   |  |
| Bruttovægt                    | 6.0KG   |  |
| Miljøbetingelser              | Handling  | Temperature: 0°C~ 40°C (32°F ~ 104°F)<br>Humidity: 10%~90% RH (non-condensing)         |
|                               | Opbevaring  | Temperatur: -20°~ 60° (-4°F ~ 140°F)<br>Luftfugtighed: 5~ 95 % RH (ikke-kondenserende) |



Udtrykkene HDMI og HDMI High-Definition Multimedia Interface og HDMI-logoet er varemærker eller registrerede varemærker tilhørende HDMI Licensing LLC i USA og andre lande.



- Bortskaf alt emballage, papir, kartoner og plastposer i overensstemmelse med dine lokale genbrugsbestemmelser.
- Ved slutningen af produktets levetid, skal det bortskaffes separat fra dit husholdningsaffald på et godkendt genbrugsplads.
- Kontakt de lokale myndigheder eller forhandleren for yderligere oplysninger.

Power International AS,  
PO Box 523, 1471 Lørenskog, Norway

Power Norge:  
<https://www.power.no/kundeservice/>  
T: 21 00 40 00

Power Danmark:  
<https://www.power.dk/kundeservice/>  
T: 70 33 80 80

Punkt 1 Danmark:  
<https://www.punkt1.dk/kundeservice/>  
T: 70 70 17 07

Power Finland:  
<https://www.power.fi/tuki/asiakaspalvelu/>  
T: 0305 0305

Power Sverige:  
<https://www.power.se/kundeservice/>  
T: 08 517 66 000

## Tuotteen esittely

### Pakkausluettelo

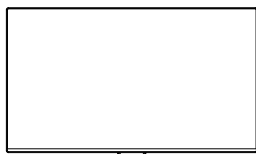

Monitori

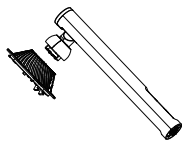

Jalusta

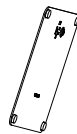

Pohjaosa



Käyttöopas

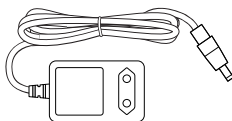

Virtasovitin

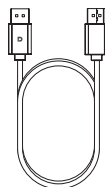

DP-kaapeli

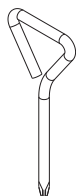

Ruuvitaltta

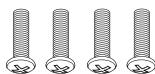

Ruuvit x 4



Ruuvit x 2

- Ylimääräisiä ruuveja voidaan käyttää vararuuveina.

## Asennus

## Jalustan asennus

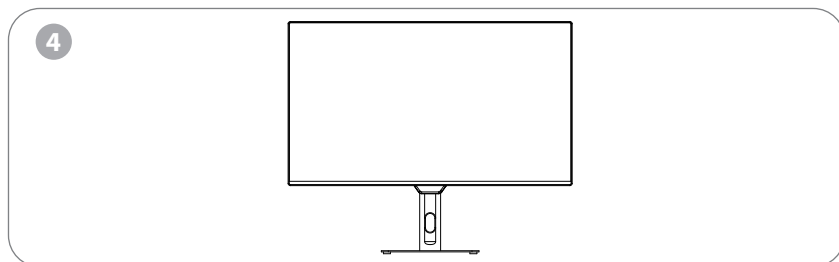
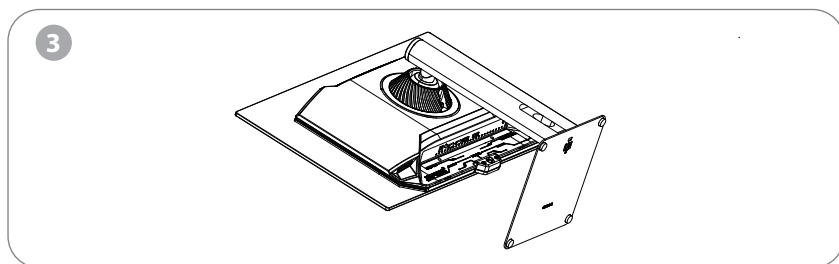
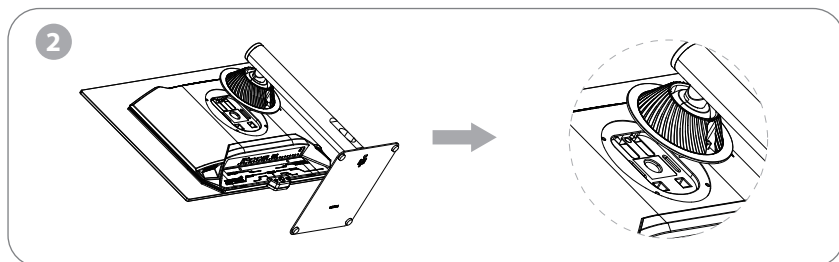
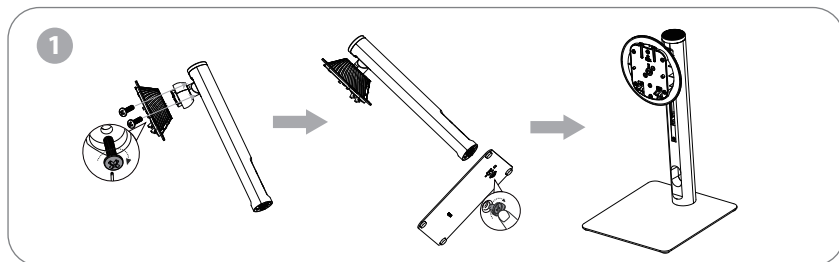

**!** Huom: Näyttöä asentaessa älä paina nestekidenäyttöä vaurioiden välttämiseksi.

## Asennus

## Seinätelineen asennus

1

Ruuvit x 4

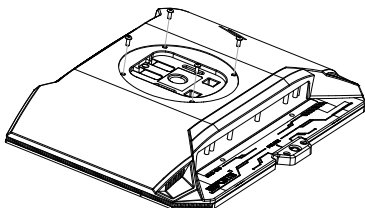

2

Kiinnike (ei sisälly)

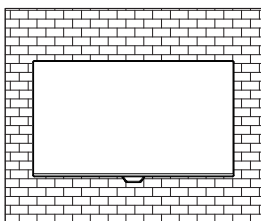
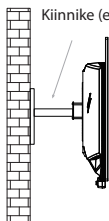

Asennuksen aikana älä purista näyttöä vahingoittumisen välttämiseksi. Katso seinätelineen (ostettava erikseen) asennusohjeet käyttöoppaasta.

**Vihje:** Tämän tuotteen kiinnitysaukkojen etäisyys on 100x100 mm.

**⚠ Huom:** Estääksesi näytön putoamisen, asenna se tukevasti ja varmista täysi suojaus. Älä sijoita tai ripusta esineitä telineeseen, ja telineen korkeus ei saa ylittää 2 metriä.

## Näytön säätäminen

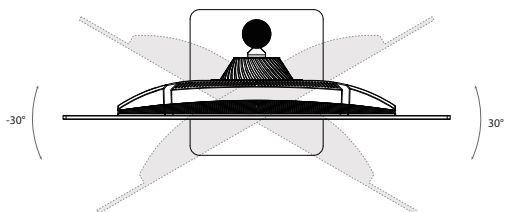

Kiertokulma  
-30°, +30°

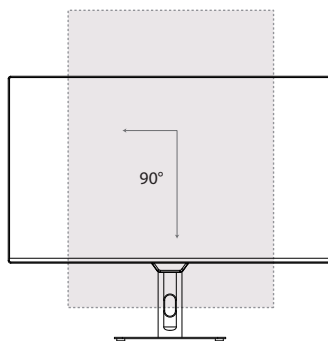

Kiertokulma 90°

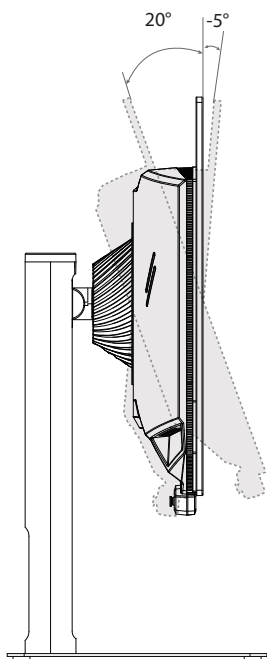

Kallistuskulma  
-5°, +20°

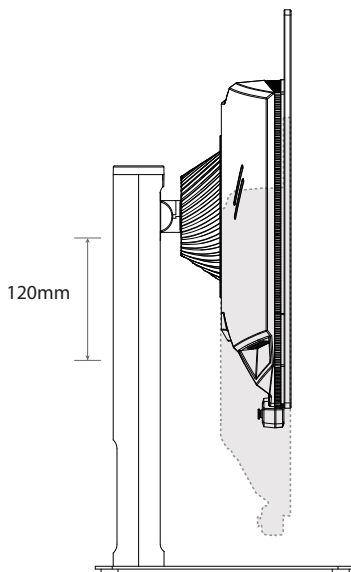





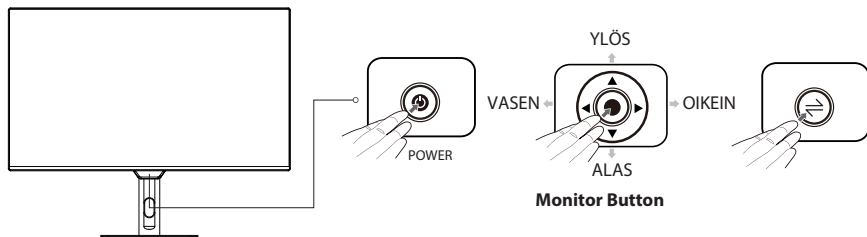

Korkeusalue  
120mm

## Käyttö

### Painikkeiden kuvaus



| Monitor Button  | Action  |
|---|---|
| <br>POWER  | Napsauta virtapainiketta käynnistääksesi näytön.                  |
| <br>YLÖS   | Mahdollistaa skenaariomallien valinnan.                           |
| <br>ALAS   | Mahdollistaa äänenvoimakkuuden säätämisen.                        |
| <br>VASEN  | Mahdollistaa signaalilähteen valinnan tai poistua OSD -valikosta. |
| <br>OIKEIN | Paina OSD -valikko.   |
|            | Cross Aiming pikan äppäin (Pelauksen aikana).                     |

### Merkkivalojen selitys

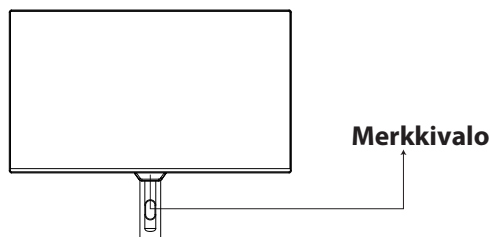

Merkkivalo: Tasainen sininen valo osoittaa, että virta on kytketty ja näyttö toimii normaalisti. Varmista, että tietokone on päällä ja että kaikki videokaapelit on kytketty ja/tai liitetty.

## OSD-valikko

### Valikon kuvaus

- Varsinaisen näytön OSD-valikon väri ja muoto voivat poiketa hieman kuvassa esitetyistä.
- OSD-valikon tekniset tiedot voivat muuttua toimintojen parannusten myötä ilman ennakoilmoitusta.

Näytön näyttövalikkoa (OSD-valikko) voidaan käyttää monitorin asetusten säätämiseen, ja se tulee näyttöön, kun monitori on kytketty päälle ja ►painiketta painetaan.

1. Paina ►siirtyäksesi OSD-näyttöön.

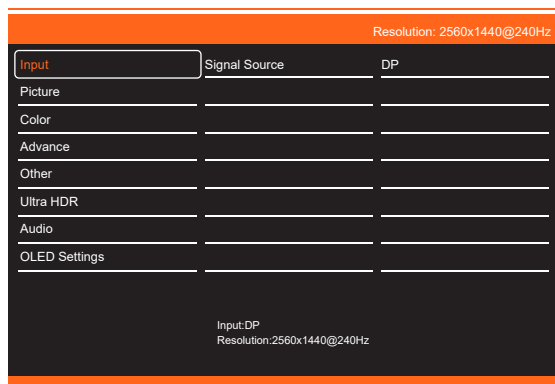

2. Selaa toimintoja painamalla ▼ tai ▲.
  - Valitse haluamasi toiminto ja siirry sitten alivalikkoon painamalla ►painiketta.
  - Selaa alivalikoita painamalla ▼ tai ▲ ja vahvista sitten haluamasi toiminnon valinta painamalla ►näppäintä.
  - Valitse vaihtoehto painamalla tai ja vahvista sitten asetus painamalla ►ja poistu nykyisestä valikosta.
3. Poistu valikkokäyttöliittymästä painamalla ◀.

## Tekniset tiedot

|                           |                 |  |
|---------------------------|-----------------|--|
| Tuotteen malli            |                 | C27ESPORTP4  |
| Näyttöruudun koko         |                 | 27" (68cm)   |
| Kuvasuhte                 |                 | 16:9   |
| Katselukulma              |                 | 178°(H) / 178°(V)  |
| Pikseliväli               |                 | 0.2292 (H) × 0.2292 (V) mm   |
| Kontrastisuhte            |                 | 1,500,000:1 (TYP)  |
| Värit                     |                 | 1.07B (10bit)  |
| Resoluutio                |                 | 2560x1440  |
| Suurin virkistystaajuus   |                 | 240Hz  |
| Tehotyyppe                |                 | DC24V, 3A  |
| Portit                    |                 | HDMI2.0x2 + DP1.4x1 + USB-Ax1(laiteohjelmistopäivitys) + AudioOut(äänilähtö)   |
| Tuotteen mitat<br>Jalusta | Ilman jalustaa  | 610.9 x 61.8 x 353 mm  |
|                           | Jalustan kanssa | 610.9 x 230 x 495.5 mm   |
| Kallistuskulma            |                 | Eteenpäin kallistus: 5°; Kallistus taaksepäin: 20°                             |
| Korkeusalue               |                 | 120 mm   |
| Kiertokulma               |                 | -30°, +30°   |
| Kaiutin                   |                 | 2x3W   |
| Nettopaino                |                 | 4.6KG  |
| Bruttopaino               |                 | 6.0KG  |
| Ympäristöolosuhteet       | Toiminto        | Lämpötila: 0 - 40°C (32 - 104°F)<br>Kosteus: 10 - 90 % RH (ei-kondensoituva)   |
|                           | Säilytys        | Lämpötila: -20 - 60° (-4°F ~ 140°F)<br>Kosteus: 5 - 95 % RH (ei-kondensoituva) |



Termit HDMI ja HDMI High-Definition Multimedia Interface sekä HDMI-logo ovat HDMI Licensing Administrator, Inc:n tavaramerkkejä tai rekisteröityjä tavaramerkkejä Yhdysvalloissa ja muissa maissa.



**HDMI™**  
HIGH-DEFINITION MULTIMEDIA INTERFACE



- Hävitä kaikki pakkaukset, paperi, kartongit ja muovipussit paikallisten kierrätysmääräysten mukaisesti.
- Hävitä tuote käyttöiän päätyttyä erillään kotitalousjätteestäsi valtuutetussa kotitalouksien sähkö- ja elektroniikkalaiteromun kierrätyskeskuksessa.
- Lisätietoja saat paikallisilta viranomaisilta tai jälleenmyyjältä, josta ostit tuotteen.

Power International AS,  
PO Box 523, 1471 Lørenskog, Norway

Power Norjassa:  
<https://www.power.no/kundeservice/>  
P: 21 00 40 00

Power Tanskassa:  
<https://www.power.dk/kundeservice/>  
P: 70 33 80 80

Punkt 1 Tanskassa:  
<https://www.punkt1.dk/kundeservice/>  
P: 70 70 17 07

Power Suomessa:  
<https://www.power.fi/tuki/asiakaspalvelu/>  
P: 0305 0305

Power Ruotsissa:  
<https://www.power.se/kundeservice/>  
P: 08 517 66 000

## Produktpresentation

### Innehåll i förpackningen

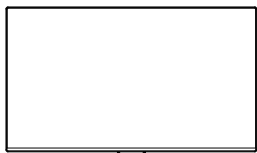

Bildskärm

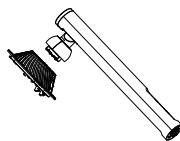

Stativ

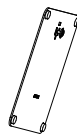

Bas



Bruksanvisning

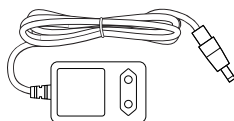

Strömadapter

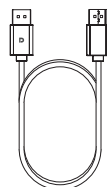

DP-kabel

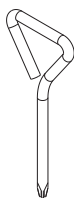

Skruvmejsel

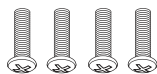

Skrubar x 4



Skrubar x 2

- Kvarvarande skruvar kan användas som reservskruvar.

## Installation

## Installation av basen

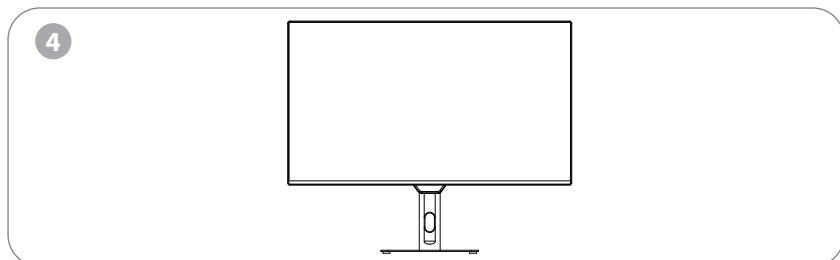
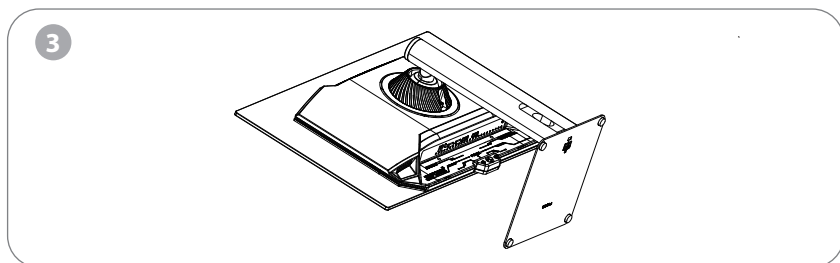
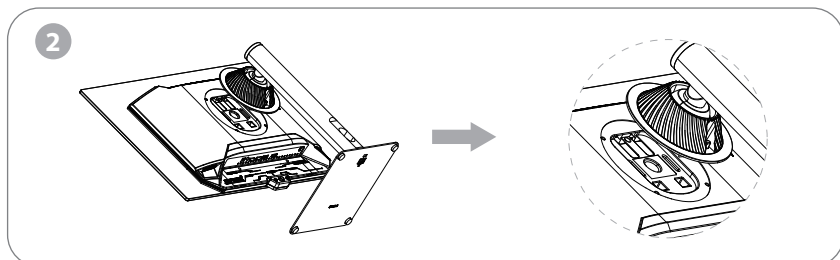
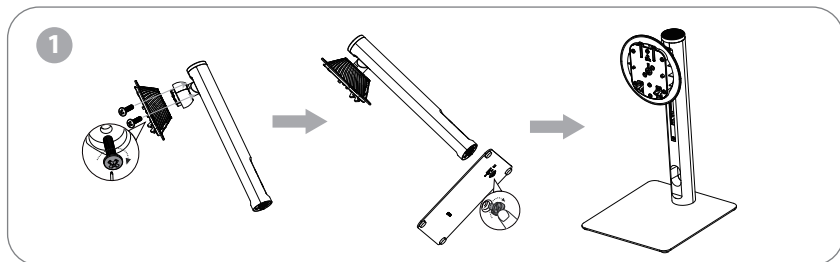

**⚠ Obs:** Vid installation av skärmen, undvik att trycka på LCD-skärmen för att undvika skador.

## Installation

### Montering av fäste

1

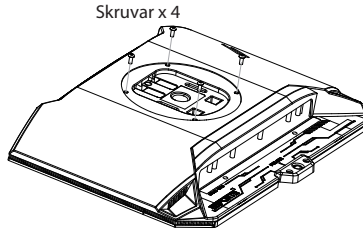

2

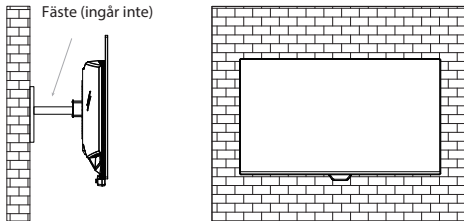

Under installationen, kläm inte skärmen för att undvika skador. Se användarmanualen för det separat inköpta väggfästet för installationsanvisningar.

**Tips:** Monteringshålsavståndet för denna produkt är 100x100 mm.

**⚠ Obs:** För att förhindra att skärmen faller, montera den säkert och säkerställ fullständigt skydd. Placera eller häng inte objekt på väggfästet, och väggfästets höjd bör vara mindre än 2 meter.

## Justera bildskärmen

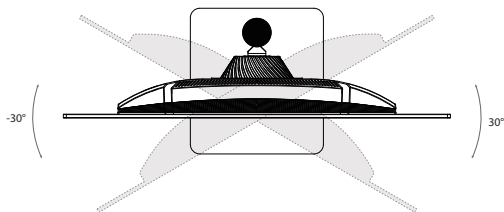

Rotationsvinkel  
-30°, +30°

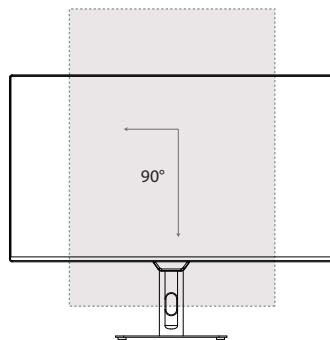

Rotationsvinkel 90°

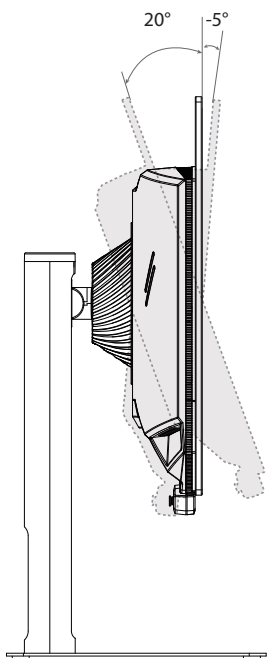

Lutningsvinkel  
-5°, +20°

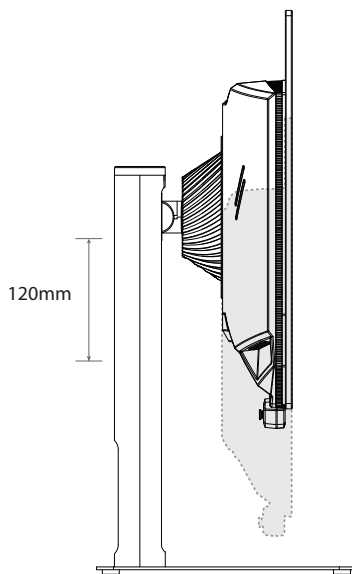





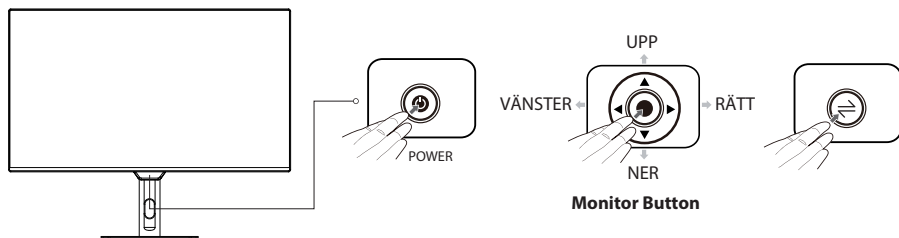

Höjdintervall  
120mm

## Användning

### Beskrivning av knappar



| Monitor Button   | Action  |
|--|---|
| <br>POWER   | Klicka på strömknappen för att slå på monitorn.       |
| <br>UPP     | Möjliggör val av scenariomönster.                     |
| <br>NER     | Möjliggör volymjustering.                             |
| <br>VÄNSTER | Tillåter val av signalkälla eller avsluta OSD -menyn. |
| <br>RÄTT    | Möjliggör justering av ljusstyrkan.                   |
|             | Korssiktning genvägsknapp (Under spel).               |

### Förklaring av indikatorer

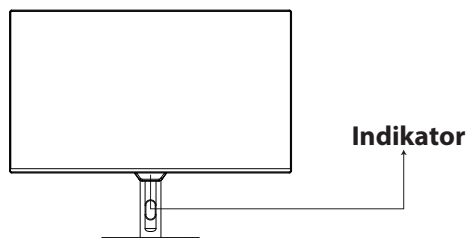

Indikator: Ett stadigt grön ljus visar att strömmen är på och att skärmen fungerar normalt. Kontrollera att datorn är påslagen och att alla videokablar är helt anslutna.

## OSD-menyn

### Beskrivning av meny

- Färgen och formen på OSD-menyn på den aktuella skärmen kan skilja sig något från dem som visas i figuren.
- Specifikationer för OSD-menyn kan ändras med förbättrade funktioner utan föregående meddelande.

OSD-menyn (On-screen display) kan användas för att justera skärmens inställningar och visas på skärmen efter att du har slagit på skärmen och trycker ►-knappen.

1. Tryck ► för att öppna OSD-skärmen.

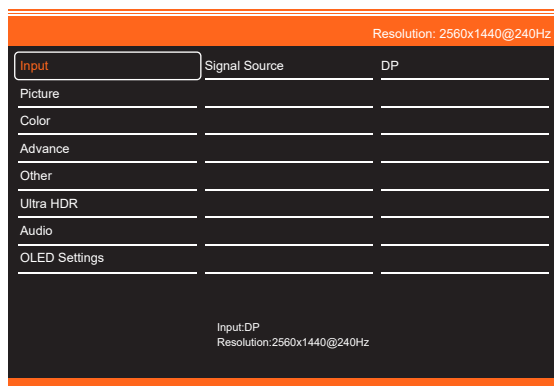

2. Tryck på ▼ eller ▲ för att bläddra bland funktionerna.
  - Välj önskad funktion och tryck sedan på ►-knappen för att komma till undermenyn.
  - Tryck på ▼ eller ▲ för att bläddra i undermenyerna och tryck sedan på ► för att bekräfta valet av önskad funktion.
  - Tryck på ▼ eller ▲ för att välja ett alternativ och tryck sedan på ► för att bekräfta inställningen och lämna den aktuella meny.
3. Tryck på ◀ för att lämna menygränssnittet.

## Specifikationer

|                              |  |   |
|------------------------------|--|---|
| Produktmodell                | C27ESPORTP4  |   |
| Skärmstorlek                 | 27" (68cm)   |   |
| Bildförhållande              | 16:9   |   |
| Visningsvinkel               | 178°(H) / 178°(V)  |   |
| Pixelavstånd                 | 0.2292 (H) × 0.2292 (V) mm                                       |   |
| Kontrastförhållande          | 1,500,000:1 (TYP)  |   |
| Färger                       | 1.07B (10bit)  |   |
| Upplösning                   | 2560x1440  |   |
| Maximal uppdateringsfrekvens | 240 Hz   |   |
| Strömtyper                   | DC24V,3A   |   |
| Portar                       | HDMI2.0x2 + DP1.4x1 + USB-Ax1 (firmwareuppdatering) + Ljudutgång |   |
| Produktmått<br>Lyftbas       | Utan bas   | 610.9 x 61.8 x 353 mm   |
|                              | Med bas  | 610.9 x 230 x 495.5 mm  |
| Lutningsvinkel               | Framåtlutning: 5°; bakåtlutning: 20°                             |   |
| Höjdintervall                | 120 mm   |   |
| Rotationsvinkel              | -30°, +30°   |   |
| Högtalare                    | 2x3W   |   |
| Nettovikt                    | 4.6KG  |   |
| Bruttovikt                   | 6.0KG  |   |
| Miljöförhållanden            | Åtgärd   | Temperatur: 0°C~ 40°C<br>Luftfuktighet: 10%~90% RH (icke-kondenserande) |
|                              | Förvaring  | Temperatur: -20°~ 60°C<br>Luftfuktighet: 5%~95% RH (icke-kondenserande) |



Termerna HDMI och HDMI High-Definition Multimedia Interface samt HDMI-logotypen är varumärken eller registrerade varumärken som tillhör HDMI Licensing Administrator, Inc. i USA och andra länder.



**HDMI**<sup>TM</sup>  
HIGH-DEFINITION MULTIMEDIA INTERFACE



- Kassera allt förpackningsmaterial, papper, kartonger och plastpåsar i enlighet med ditt lands lokala regler för återvinning.
- I slutet av produktens livslängd, kassera separat från hushållsavfallet på en godkänd WEEE-återvinningsstation.
- För ytterligare information, kontakta din kommun eller återförsäljare där du köpte produkten..

Power International AS,  
PO Box 523, N-1471 Lørenskog, Norge

Power Norge:  
<https://www.power.no/kundeservice/>  
T: 21 00 40 00

Power Danmark:  
<https://www.power.dk/kundeservice/>  
T: 70 33 80 80

Punkt 1 Danmark:  
<https://www.punkt1.dk/kundeservice/>  
T: 70 70 17 07

Power Finland:  
<https://www.power.fi/tuki/asiakaspalvelu/>  
T: 0305 0305

Power Sverige:  
<https://www.power.se/kundeservice/>  
T: 08 517 66 000

**CEPTER**